

Timber Overlay Flooring System Design Guide

FOR USE WITH GLUE DOWN PRE-FINISHED ENGINEERED PLANK FLOORING



1	PRODUCT OVERVIEW	02
	1.1-1.6 CURRENT COLLECTIONS	04
	1.7 GRADE AND COLOUR VARIATION	10
2	APPROVED SUBSTRATES	12
	2.1 APPROVED SUBSTRATES (SCOPE & LIMITATIONS OF USE)	12
	2.2 OTHER SUBSTRATES	13
3	ACOUSTIC AND IIC RATINGS (G6)	15
	3.1 IIC REQUIREMENTS	15
	3.2 CONCRETE SUBFLOOR CONSTRUCTIONS	16
	3.3 TIMBER SUBFLOOR CONSTRUCTIONS	16
4	UNDERFLOOR HEATING	18
	4.1 DESIGN REQUIREMENTS	19
	4.2 UNDERFLOOR HEATING SYSTEM COMPATIBILITY	20
	4.3 ADDITIONAL CARE & MAINTENANCE WITH UNDERFLOOR HEATING	21
5	WET AREAS (E3)	23
	5.1 SHOULD I SPECIFY AN ALTERNATIVE SOLUTION OR E3/AS2?	24
	5.2 ALTERNATIVE SOLUTION (INSTALL WITH D3 PVA/CAULKING IN JOINTS)	27
	5.3 INSTALL OVER A WET AREA MEMBRANE (E3/AS2)	28
6	STAIRWAY DESIGN AND ACCESS (D1)	30
	6.1 STAIRWAY DESIGN OVERVIEW	30
	6.2 FORTÉ STANDARD NOSING DESIGN & APPLICATIONS	30
	6.3 FORTÉ PREMIUM NOSING DESIGN & APPLICATIONS	32
	6.4 FORTÉ ACCESSIBLE NOSING DESIGN & APPLICATIONSE	32
	6.5 SLIP RESISTANCE	36
7	FINISHINGS & FLOORING HEIGHTS	39
	7.1 FLOORING HEIGHTS	39
	7.2 TIMBER TO CARPET	43
	7.3 TIMBER TO TIMBER	43
	7.4 TIMBER TO TILE	44
	7.5 TIMBER TO POLISHED CONCRETE / GARAGE FLOOR	44
	7.6 TIMBER TO JOINERY	45
	7.7 TIMBER TO FRONT DOOR	46
	7.8 SKIRTINGS	46
8	ENERGY EFFICIENCY (H1)	49
	8.1 UNDERFLOOR HEATING CONSIDERATIONS	49
	8.2 LRV	50
9	MAINTAINING A STABLE CLIMATE	53
11	HISTORIC PRODUCTS	56

1. Product Overview | Current

Collection	Scope	Construction	Certifications	Formats Available	Status	Lead Time	Plank Dimensions	RRP per m ²	Trade Price per m ²	Page No.
/loft	Budget-friendly and durable, ideal for commercial spaces, large-scale projects, and busy homes, providing affordability without compromising quality.	2-Layer Engineered European Oak Veneer Eucalypt Plywood Base	CodeMark Pending FSC certified E0 Low Voc	193mm Plank	Stocked	1-8 Weeks	12/2 x 193 x 1830mm	\$122.00	\$98.00	6
/urban	Combines affordability with the beauty of real timber, suitable for renovations and new builds, offering an authentic timber aesthetic at an affordable pricepoint.	3-Layer Engineered European Oak Veneer Hevea Core Spruce Backing	CodeMark PEFC Certified E0 Low Voc	190mm Plank	Stocked	1-8 Weeks	14/3 x 190 x 1830mm	\$157.00 - \$197.00	\$126.00 - \$158.00	7
/moda VITA	Versatile collection for a range of residential and commercial projects, with customisable options including different plank widths and herringbone patterns, offering flexibility in design.	2-Layer Engineered European Oak Veneer Eucalypt Plywood Base	CodeMark Pending PEFC Certified E0 Low Voc	220mm Plank Herringbone	Stocked Stocked	1-8 Weeks 1-8 Weeks	15/4 x 220 x 2200mm 15/4 x 120 x 600mm		\$156.00 - \$200.00	8
/smartfloor	Reliable choice for residential settings, providing a traditional aesthetic with low maintenance, complementing classic interior styles and offering a timeless look.	2-Layer Engineered European Oak Veneer Eucalypt Plywood Base	CodeMark Pending FSC on request E0 Low Voc	190mm Plank Herringbone Chevron	Stocked Stocked Custom Order	1-8 Weeks 1-8 Weeks 16 Weeks	15/4 x 190 x 2200mm 15/4 x 120 x 600mm 15/4 x 120 x 600mm	\$194.00 - \$285.00	\$156.00 - \$200.00	8
/indus	Premium choice for design-oriented projects, suited for high-end residential and commercial spaces, enhancing the luxurious feel with modern hues and wide planks.	2-Layer Engineered European Oak Veneer Meranti Plywood Base	CodeMark Pending FSC on request E0 Low Voc	240mm Plank Herringbone	Stocked Stocked	1-8 Weeks 1-8 Weeks	18/4 x 240 x 2400mm 18/4 x 120 x 600mm	\$272.00 - \$446.00	\$218.00 - \$358.00	9
/atelier	Versatile and sophisticated colours, suitable for high-end residential spaces, offering custom options for unique rustic charm and contemporary elegance.	2-Layer Engineered European Oak Veneer Eucalypt Plywood Base	CodeMark Pending FSC on request E0 Low Voc	220mm Plank 260mm Plank Herringbone Chevron	Stocked Stocked Custom Order Custom Order	1-8 Weeks 16 Weeks 16 Weeks 16 Weeks	15/4 x 220 x 2200mm 21/6 x 260 x 2200mm 15/4 x 120 x 600mm 15/4 x 120 x 600mm	\$278.00 - \$337.00	\$223.00 - \$271.00	10
/ultra	Robust collection for residential and commercial spaces requiring top-quality flooring, featuring a 6mm veneer for luxury and longevity.	2-Layer Engineered European Oak Veneer Eucalypt Plywood Base	CodeMark Pending FSC on request E0 Low Voc	190mm Plank	Stocked	1-8 Weeks	21/6 x 190 x 1900mm	\$296.00 - \$345.00	\$230.00 - \$277.00	10
/artefact	A luxury collection for residential projects, featuring rustic grade engineered timber that encompasses a plethora of natural colour and grain variation.	2-Layer Engineered European Oak Veneer Birch Plywood Base	FSC on request E0 Low Voc	220mm Plank	Stocked	1-8 Weeks	15/4 x 220 x 2200mm	\$316.00	\$254.00	13
/villa	Provides a bold, rustic aesthetic, making it a premium choice for high-end residential and commercial projects, showcasing a 'distinct rough sawn texture and character-filled look.	2-Layer Engineered European Oak Veneer Meranti Plywood Base	FSC on request E0 Low Voc	240mm Plank Herringbone	Stocked Stocked	16 Weeks 16 Weeks	18/4 x 240 x 2400mm 18/4 x 120 x 600mm	\$310.00	\$249.00	13
/artiste GRANDE	A luxurious collection for those seeking the authentic texture of natural timber, featuring rustic aged wide planks for a vintage aesthetic in high-end residential projects.	2-Layer Engineered European Oak Veneer Birch Plywood Base	FSC on request E0 Low Voc	250mm Plank Herringbone Chevron	Custom Order Custom Order Custom Order	16 Weeks 16 Weeks 16 Weeks	19/5 x 250 x 2500mm 19/5 x 120 x 720mm 19/5 x 120 x 600mm	\$508.00 - \$550.00	\$408.00 - \$442.00	13

1.1

LIGHT/BLOND

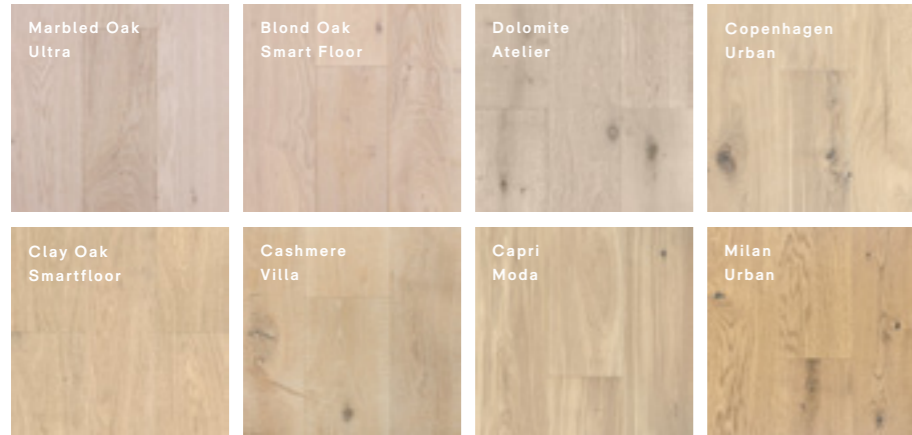

1.2

GOLDEN

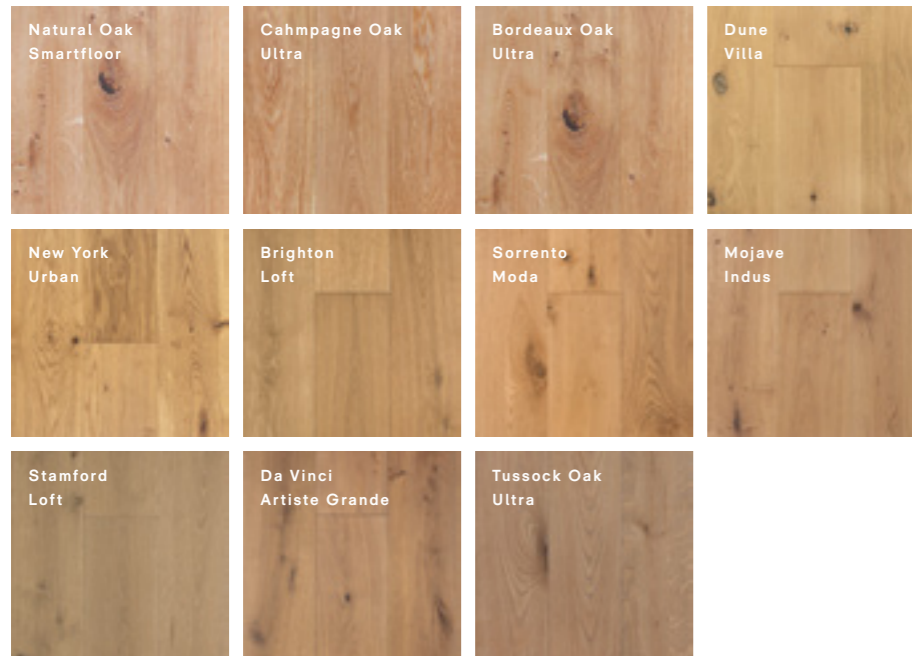

Collection	Colour	Format	Grade	Code	Dimensions
Light/Blond					
Urban	Copenhagen	Plank	Feature	UR-CFP	14 T x 190 W x 1830mm L
		Plank	Prime	UR-CPP	14 T x 190 W x 1830mm L
Moda	Capri	Plank	Feature	MOV-CAFP	15 T x 220 W x 2200mm L
		Plank	Light Feature	MOV-CALFP	15 T x 220 W x 2200mm L
		Herringbone	Light Feature	MOV-CALFH	15 T x 120 W x 600mm L
Smartfloor	Blond Oak	Plank	Feature	SBOF190	15 T x 190 W x 2200mm L
		Plank	Light Feature	SBO190	15 T x 190 W x 1900mm L
		Herringbone	Light Feature	SBO190	15 T x 120 W x 600mm L
	Clay Oak	Plank	Feature	SCOF220	15 T x 220 W x 2200mm L
		Plank	Light Feature	SCO220	15 T x 220 W x 2200mm L
		Herringbone	Light Feature	SCOHB120	15 T x 120 W x 600mm L
Ultra	Marbled Oak	Plank	Prime	UL-MPP	21 T x 190 W x 1900mm L
		Plank	Rustic	VI-CRSP	18 T x 240 W x 2400mm L
Villa	Cashmere	Herringbone	Rustic	VI-CRSH	18 T x 120 W x 600mm L
		Golden			
Loft	Brighton	Plank	Feature	LO-BTFP	12 T x 193 W x 1830mm L
	Stamford	Plank	Feature	LO-SFFP	12 T x 193 W x 1830mm L
Urban	New York	Plank	Feature	UR-NYFP	14 T x 190 W x 1830mm L
		Plank	Prime	UR-NYPP	14 T x 190 W x 1830mm L
Moda	Sorrento	Plank	Feature	MOV-SFP	15 T x 220 W x 2200mm L
		Herringbone	Light Feature	MOV-SLFH	15 T x 120 W x 600mm L
Smartfloor	Natural Oak	Plank	Feature	SNOF190	15 T x 190 W x 2200mm L
		Plank	Light Feature	SNO190	15 T x 190 W x 1900mm L
		Herringbone	Light Feature	SNOHB120	15 T x 120 W x 600mm L
Indus	Mojave	Plank	Feature	IN-MFP	18 T x 240 W x 2400mm L
		Plank	Prime	IN-MPP	18 T x 240 W x 2400mm L
Ultra	Champagne Oak	Plank	Prime	UL-CPP-190	21 T x 190 W x 1900mm L
	Bordeaux Oak	Plank	Feature	UL-BFP-190	21 T x 190 W x 1900mm L
	Tussock Oak	Plank	Feature	UL-TFP-190	21 T x 190 W x 1900mm L
Villa	Dune	Plank	Rustic	VI-DRSP	18 T x 240 W x 2400mm L
		Herringbone	Rustic	VI-DRSH	18 T x 120 W x 600mm L
Artiste Grande	Da Vinci	Plank	Rustic	AG-DVRP	19 T x 250 W x 2500mm L
		Chevron	Rustic	AG-DVRC	19 T x 120 W x 600mm L
		Herringbone	Rustic	AG-DVRH	19 T x 120 W x 720mm L

1.3

NEUTRAL WARM

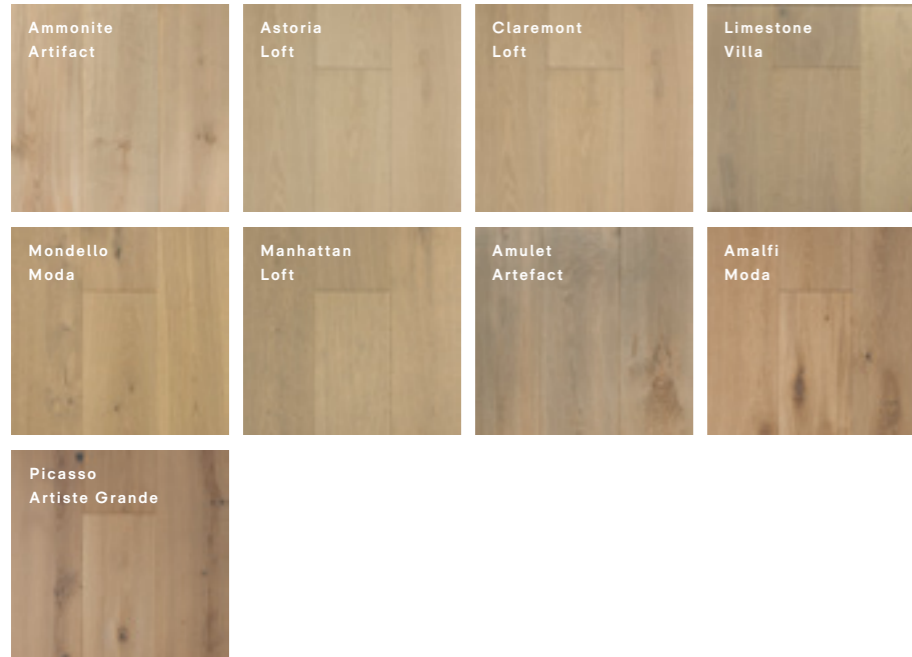

1.4

NEUTRAL COOL

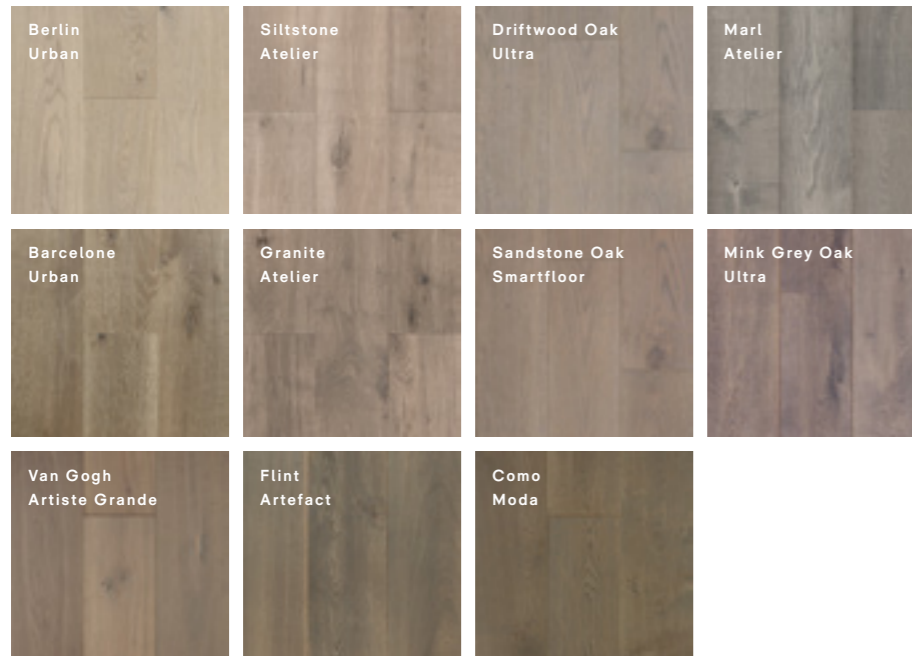

Collection	Colour	Format	Grade	Code	Dimensions
Neutral Warm					
Loft	Astoria	Plank	Feature	LO-AFP	12 T x 193 W x 1830mm L
	Claremont	Plank	Feature	LO-CFP	12 T x 193 W x 1830mm L
	Manhattan	Plank	Feature	LO-MFP	12 T x 193 W x 1830mm L
Moda	Amalfi	Plank	Feature	MOV-AFP	15 T x 220 W x 2200mm L
	Mondello	Plank	Feature	MOV-MFP	15 T x 220 W x 2200mm L
		Herringbone	Feature	MOV-MFH	15 T x 120 W x 600mm L
Artefact	Ammonite	Plank	Rustic	ART-AMMRP	15 T x 220 W x 1800-2200mm L
		Herringbone	Rustic	ART-AMMRH	15 T x 135 W x 600mm L
	Amulet	Plank	Rustic	ART-AMURP	15 T x 220 W x 1800-2200mm L
Herringbone		Rustic	ART-AMURH	15 T x 135 W x 600mm L	
Villa	Limestone	Plank	Rustic	VI-LRSP	18 T x 240 W x 2400mm L
		Herringbone	Rustic	VI-LRSH	18 T x 120 W x 600mm L
Artiste Grande	Picasso	Plank	Rustic	AG-PRP	19 T x 250 W x 2500mm L
		Chevron	Rustic	AG-PRC	19 T x 120 W x 600mm L
		Herringbone	Rustic	AG-PRH	19 T x 120 W x 720mm L
Neutral Cool					
Urban	Berlin	Plank	Feature	UR-BEFP	14 T x 190 W x 1830mm L
	Barcelona	Plank	Feature	UR-BAFP	14 T x 190 W x 1830mm L
Moda	Como	Plank	Feature	MOV-CFP	15 T x 220 W x 2200mm L
Smartfloor	Sandstone Oak	Plank	Feature	SBOF190	15 T x 190 W x 2200mm L
Atelier	Granite	Plank 220	Rustic	AT-GRP15	15 T x 220 W x 2200mm L
		Plank 260	Rustic	AT-GRP21	21 T x 260 W x 2200mm L
		Herringbone	Rustic	AT-GRH15	15 T x 120 W x 600mm L
	Siltstone	Plank 220	Rustic	AT-SRP15	15 T x 220 W x 2200mm L
		Plank 260	Rustic	AT-SRP21	21 T x 260 W x 2200mm L
		Herringbone	Rustic	AT-SRH15	15 T x 120 W x 600mm L
	Marl	Plank 220	Rustic	AT-MRP15	15 T x 220 W x 2200mm L
		Plank 260	Rustic	AT-MRP21	21 T x 260 W x 2200mm L
		Herringbone	Rustic	AT-MRH15	15 T x 120 W x 600mm L
Ultra	Driftwood Oak	Plank	Feature	UL-DFP-190	21 T x 190 W x 1900mm L
	Mink Grey Oak	Plank	Feature	UL-MGFP-190	21 T x 190 W x 1900mm L
Artefact	Flint	Plank	Rustic	ART-FLRP	15 T x 220 W x 1800-2200mm L
		Herringbone	Rustic	ART-FLRH	15 T x 135 W x 600mm L
Artiste Grande	Van Gogh	Plank	Rustic	AG-VGRP	19 T x 250 W x 2500mm L
		Chevron	Rustic	AG-VGRC	19 T x 120 W x 600mm L
		Herringbone	Rustic	AG-VGRH	19 T x 120 W x 720mm L

1.5

MID BROWN

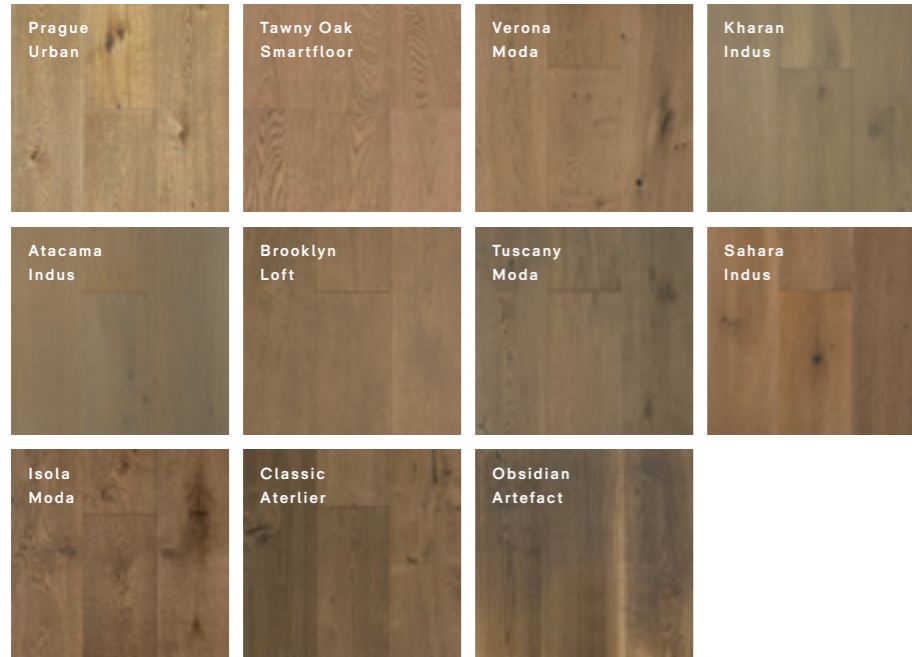

1.6

DARK BROWN/BLACK

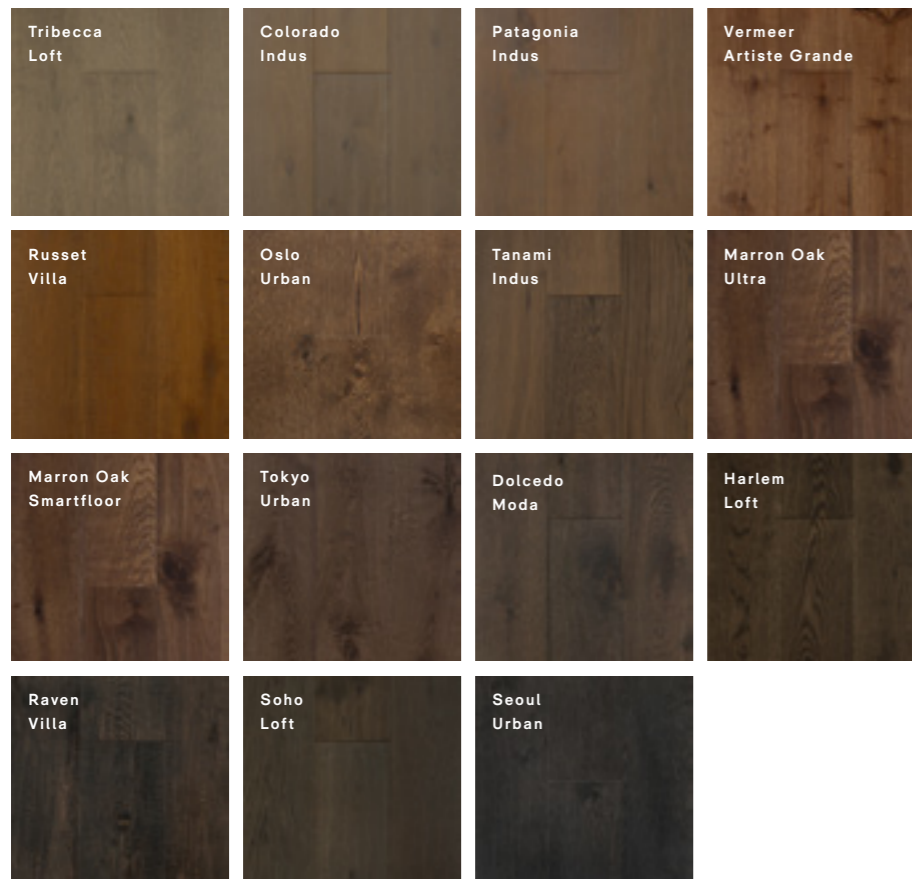

Collection	Colour	Format	Grade	Code	Dimensions		
Mid Brown							
Loft	Brooklyn	Plank	Feature	LO-BFP	12 T x 193 W x 1830mm L		
Urban	Prague	Plank	Feature	UR-PFP	14 T x 190 W x 1830mm L		
Moda	Isola	Plank	Feature	MOV-IFP	15 T x 220 W x 2200mm L		
		Plank	Feature	MOV-TFP	15 T x 220 W x 2200mm L		
		Plank	Feature	MOV-VFP	15 T x 220 W x 2200mm L		
		Herringbone	Feature	MOV-VFH	15 T x 120 W x 600mm L		
Smartfloor	Tawny Oak	Plank	Feature	STO220	15 T x 190 W x 2200mm L		
		Herringbone	Light Feature	STOHB120	15 T x 120 W x 600mm L		
		Chevron	Light Feature	STOC120	15 T x 120 W x 600mm L		
Indus	Atacama	Plank	Feature	IN-AFP	18 T x 240 W x 2400mm L		
		Plank	Prime	IN-APP	18 T x 240 W x 2400mm L		
		Herringbone	Light Feature	IN-AFH	18 T x 120 W x 600mm L		
		Plank	Feature	IN-KFP	18 T x 240 W x 2400mm L		
	Sahara	Plank	Feature	IN-SFP	18 T x 240 W x 2400mm L		
		Herringbone	Light Feature	IN-SFH	18 T x 120 W x 600mm L		
		Atelier	Classic	Plank 220	Rustic	AT-CRP15	15 T x 220 W x 2200mm L
				Plank 260	Rustic	AT-CRP21	21 T x 260 W x 2200mm L
Herringbone	Rustic			AT-CRH15	15 T x 120 W x 600mm L		
Artefact	Obsidian	Plank	Rustic	ART-ORP	15 T x 220 W x 1800-2200mm L		
		Herringbone	Rustic	ART-ORH	15 T x 135 W x 600mm L		
Dark Brown/Black							
Loft	Harlem	Plank	Feature	LO-HFP	12 T x 193 W x 1830mm L		
	Soho	Plank	Feature	LO-SFP	12 T x 193 W x 1830mm L		
	Tribeca	Plank	Feature	LO-TFP	12 T x 193 W x 1830mm L		
Urban	Oslo	Plank	Feature	UR-OFP	14 T x 190 W x 1830mm L		
		Plank	Feature	UR-TFP	14 T x 190 W x 1830mm L		
		Plank	Feature	UR-SFP	14 T x 190 W x 1830mm L		
		Moda	Dolcedo	Plank	Feature	MOV-DFP	15 T x 220 W x 2200mm L
Herringbone	Feature			MOV-DFH	15 T x 120 W x 600mm L		
Smartfloor	Marron Oak	Plank	Feature	SMO190	15 T x 190 W x 2200mm L		
		Herringbone	Light Feature	SMOHB120	15 T x 120 W x 600mm L		
Indus	Colorado	Plank	Feature	IN-CFP	18 T x 240 W x 2400mm L		
		Plank	Feature	IN-PFP	18 T x 240 W x 2400mm L		
	Patagonia	Herringbone	Light Feature	IN-PFH	18 T x 120 W x 600mm L		
		Tanami	Plank	Feature	IN-TFP	18 T x 240 W x 2400mm L	
Ultra	Marron Oak	Plank	Feature	UL-MFP-190	21 T x 190 W x 1900mm L		
Villa	Raven	Plank	Rustic	VI-RRSP	18 T x 240 W x 2400mm L		
		Herringbone	Rustic	VI-RRSH	18 T x 120 W x 600mm L		
	Russet	Plank	Rustic	VI-RURSP	18 T x 240 W x 2400mm L		
		Herringbone	Rustic	VI-RURSH	18 T x 120 W x 600mm L		
Artiste Grande	Vermeer	Plank	Rustic	AG-VRP	19 T x 250 W x 2500mm L		
		Chevron	Rustic	AG-VRC	19 T x 120 W x 600mm L		
		Herringbone	Rustic	AG-VRH	19 T x 120 W x 720mm L		

1.7

GRADE AND COLOUR VARIATION

You will notice that some wood floors are full of knots and cracks and have varying colours between planks, and others are quite clear with little to no markings. This is due to the grade of the wood and the colour variation.



PRIME GRADE

The most expensive grade due to its clean and minimalistic appearance. This grade of Oak has very few imperfections, if any, and minimal colour and grain variation. It is harder to come by as the planks are cut from the centre of the tree, and there is only a 10% yield of prime grade oak in one tree.

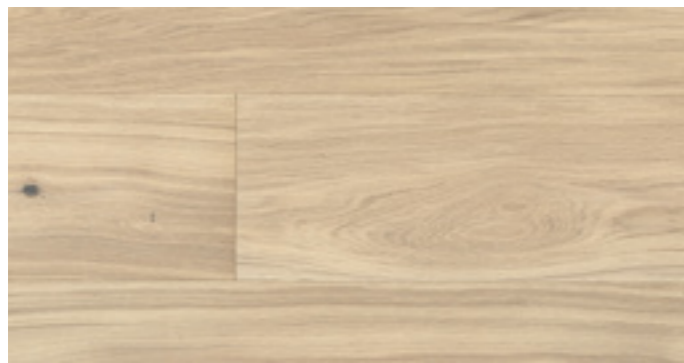

LIGHT FEATURE GRADE

A grade of wood with slightly more features than a Prime Grade wood, meaning the boards will be reasonably clear but will contain a small number of knots, general features and colour variation, giving the floor a cleaner look.



FEATURE GRADE

This is a mid-range grade of wood with a higher level of natural characteristics than a Prime Grade, with larger and more frequent knots and cracks filled with epoxy and increased colour and grain variation.

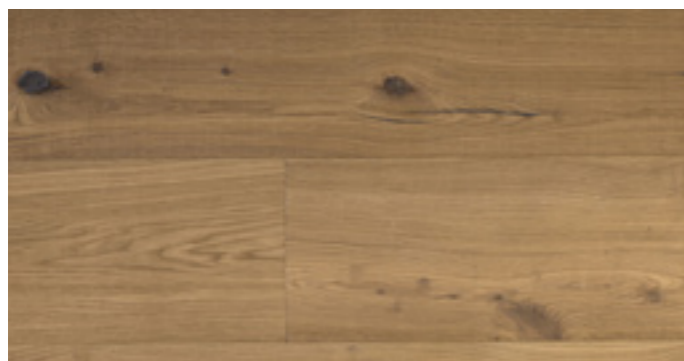

RUSTIC GRADE

A heavy character grade with unlimited knots of all sizes and extensive colour and grain variation. This grade can include open surface cracks and knots, giving it a rougher texture and a more unrefined and natural appearance.

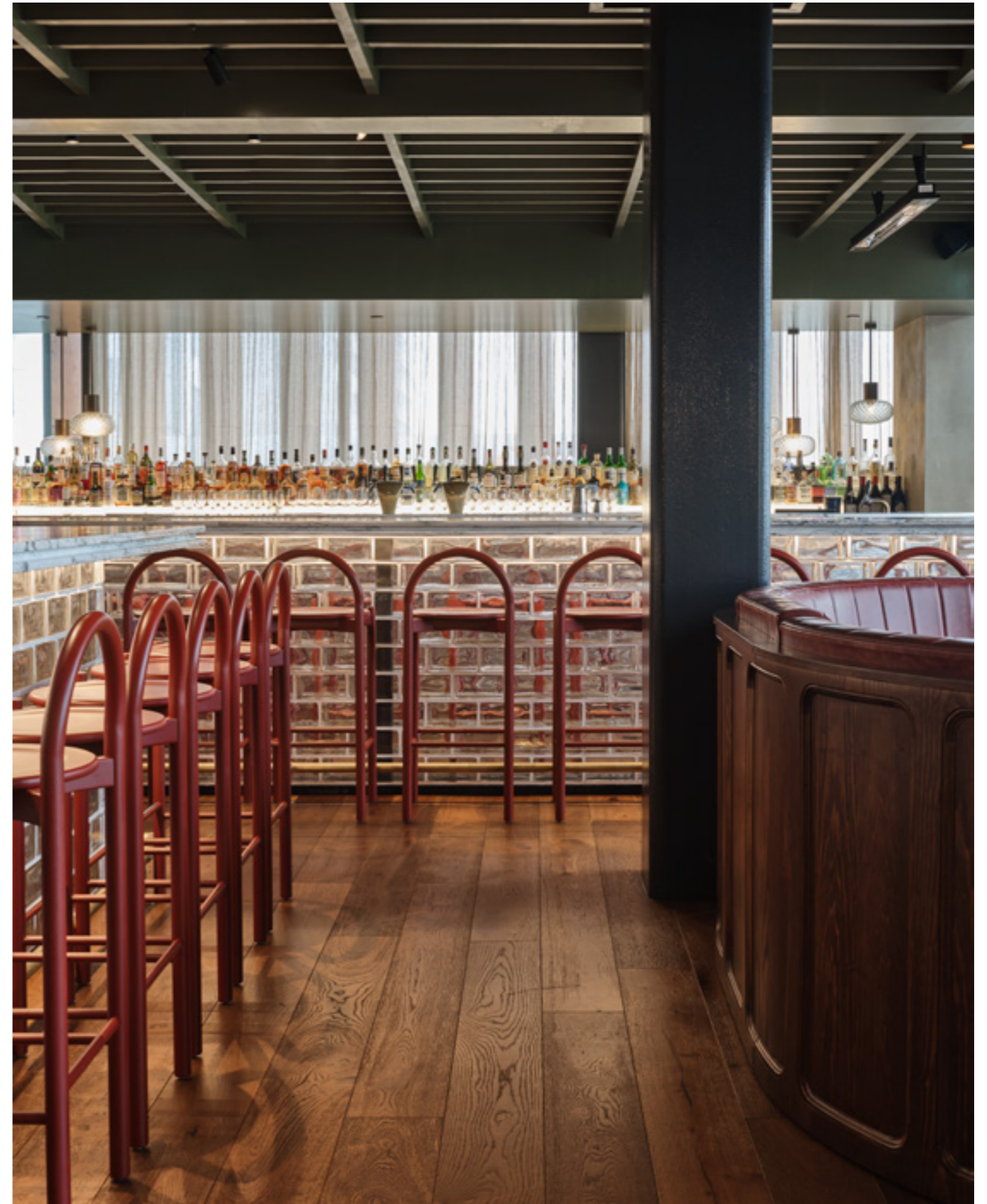

2. Approved Substrates

2.1

APPROVED SUBSTRATES (SCOPE & LIMITATIONS OF USE)

Substrate	Scope	Limitations of Use
Concrete Slab-on-grade or suspended	Acoustic and IIC Ratings If IIC 55 Rating required for Multi-Storey Building	Refer to 3.2
	Underfloor Heating Hydronic or In-Screed Systems	Refer to 4.3
	Wet Areas (E3) Recommended to follow Forté Alternative Solution	Refer to 5.1
	Stairway Design & Access (D1) Additional requirements for Accessible stairways	Refer to 6.1-6.5
	Maintaining a Stable Climate	Refer to 9
Other		<ul style="list-style-type: none"> - The flooring is suitable for all areas other than garages and commercial kitchens. - The flooring should be separated from fuel-burning appliances, flues, and chimneys in accordance with NZBC Section C AS/1. - For installations where a single length/run of the timber flooring will be over 15 meters, please contact Forté to ensure suitability for installation.
Timber - Plywood Structural (minimum 18mm) or Overlay, but not timber joists	Acoustic and IIC Ratings If IIC 55 Rating required for Multi-Storey Building	Refer to 3.3
	Underfloor Heating In-Screed Systems	Refer to 4.3
	Wet Areas (E3) Recommended to follow Forté Alternative Solution if using H3 Plywood	Refer to 5.1
	Stairway Design & Access (D1) Additional requirements for Accessible stairways	Refer to 6.1-6.5
	Maintaining a Stable Climate	Refer to 9
Other		<ul style="list-style-type: none"> - The flooring is suitable for all areas other than garages and commercial kitchens. - The flooring should be separated from fuel-burning appliances, flues, and chimneys in accordance with NZBC Section C AS/1. - For installations where a single length/run of the timber flooring will be over 15 meters, please contact Forté to ensure suitability for installation.
Timber - Other Structural (18mm+) or Overlay, but not timber joists (Particleboard, Oriented Strand board, or Existing solid timber)	Acoustic and IIC Ratings If IIC 55 Rating required for Multi-Storey Building	Refer to 3.3
	Underfloor Heating In-Screed Systems	Refer to 4.3
	Wet Areas (E3) E3/AS2 Membrane required if the subfloor is not H3 Plywood	Refer to 5.1
	Stairway Design & Access (D1) Additional requirements for Accessible stairways	Refer to 6.1-6.5
	Maintaining a Stable Climate	Refer to 9
Other		<ul style="list-style-type: none"> - The flooring is suitable for all areas other than garages and commercial kitchens. - The flooring should be separated from fuel-burning appliances, flues, and chimneys in accordance with NZBC Section C AS/1. - For installations where a single length/run of the timber flooring will be over 15 meters, please contact Forté to ensure suitability for installation.

2.2

OTHER SUBSTRATES

Substrate	Scope & Limitations of Use
Fibre Cement E.g James Hardie Secura	<p>The substrate product supplier must also state their product is suitable for use under Glue-Down Timber Flooring</p> <p>The substrate should be structurally sound, level, and free from contaminants.</p> <p>Specific primers, screeds, and adhesives may be required depending on buildup for these substrates. Please enquire with Forté Technical Support for specific advice.</p>
Magnesium Oxide Board E.g. Maglok Dragonboard	
Tile Board (extruded polystyrene) E.g. Marmox Multiboard	
Ceramic Tiles, Stone, Terazzo	





3. Acoustic and IIC Ratings (G6)

Flooring acoustics are an important consideration in multi-residential building design and construction. The Impact Insulation Class (IIC) is a measure of a flooring system's ability to reduce impact sound.

There are specific requirements for acoustics specified in the New Zealand Building Code (NZBC). Please note that the NZBC requirements only apply to residential uses.

3.1 IIC REQUIREMENTS

Building elements which are common between occupancies, shall be constructed to prevent undue noise transmission from other occupancies or common spaces, to the habitable spaces of household units.

Under G6.3.2 the IIC requirement for the Impact Insulation Class of floors shall be no less than 55.

3.2

CONCRETE SUBFLOOR CONSTRUCTIONS

All our flooring Collections exceed the minimum requirement of IIC 55 when installed with an Accoustick-Mat Underlay. All acoustic test reports are available in the links below.

Forté Collection	Result*	Test Report
Loft 12mm	IIC 60	Rp 001 20230465
Urban 14mm		
Moda 15mm		
Smartfloor 15mm	IIC 56	Rp 007 2016596A
Artefact 15mm		
Atelier 15mm		
Artiste Grande 19mm		
Atelier 21mm		
Indus 18mm	IIC 55	Rp 008 2016596A
Ultra 21mm		
Villa 18mm		

*120mm Concrete Slab with Cavity Insulation and Minimum 13mm Plasterboard Ceiling

When installing engineered timber flooring over a concrete subfloor, the Impact Insulation Class (IIC) rating can vary depending on several factors. General design considerations are as follows:

Install engineered timber flooring with an acoustic underlay between the timber and the concrete subfloor to improve the IIC rating.

3.3

TIMBER SUBFLOOR CONSTRUCTIONS

Achieving result is dependent on a number of factors. We recommend to work with an architect and acoustic engineer to ensure the build up achieves the required IRC rating.

Product may be required from Forté for testing specific build ups. Forté is happy to provide product for testing if this is required.

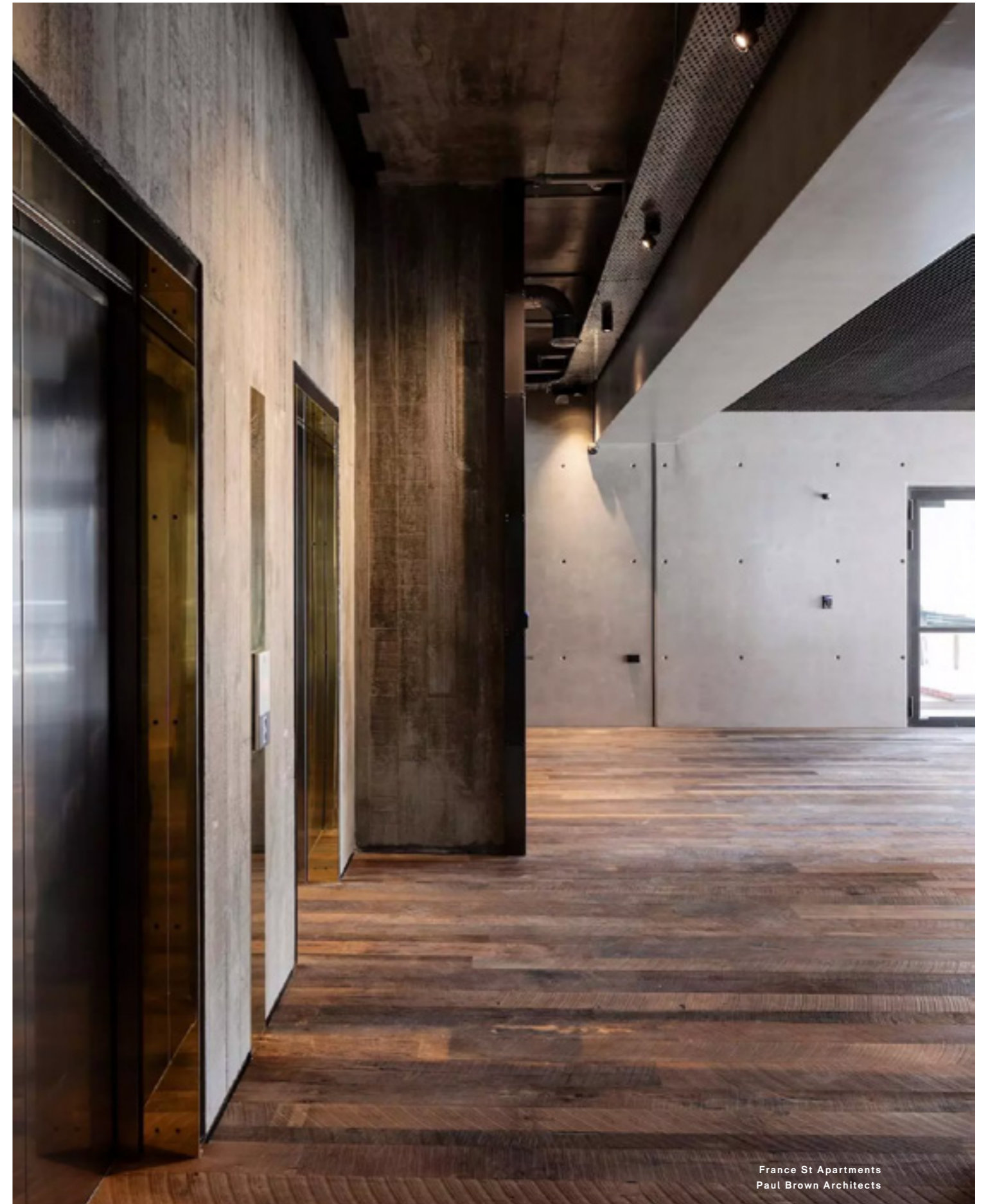

France St Apartments
Paul Brown Architects

4. Underfloor Heating

When installing timber flooring over underfloor heating, additional requirements for both the underfloor heating system and the flooring being installed must be adhered to so risk is minimised and to ensure the warranty is not voided.

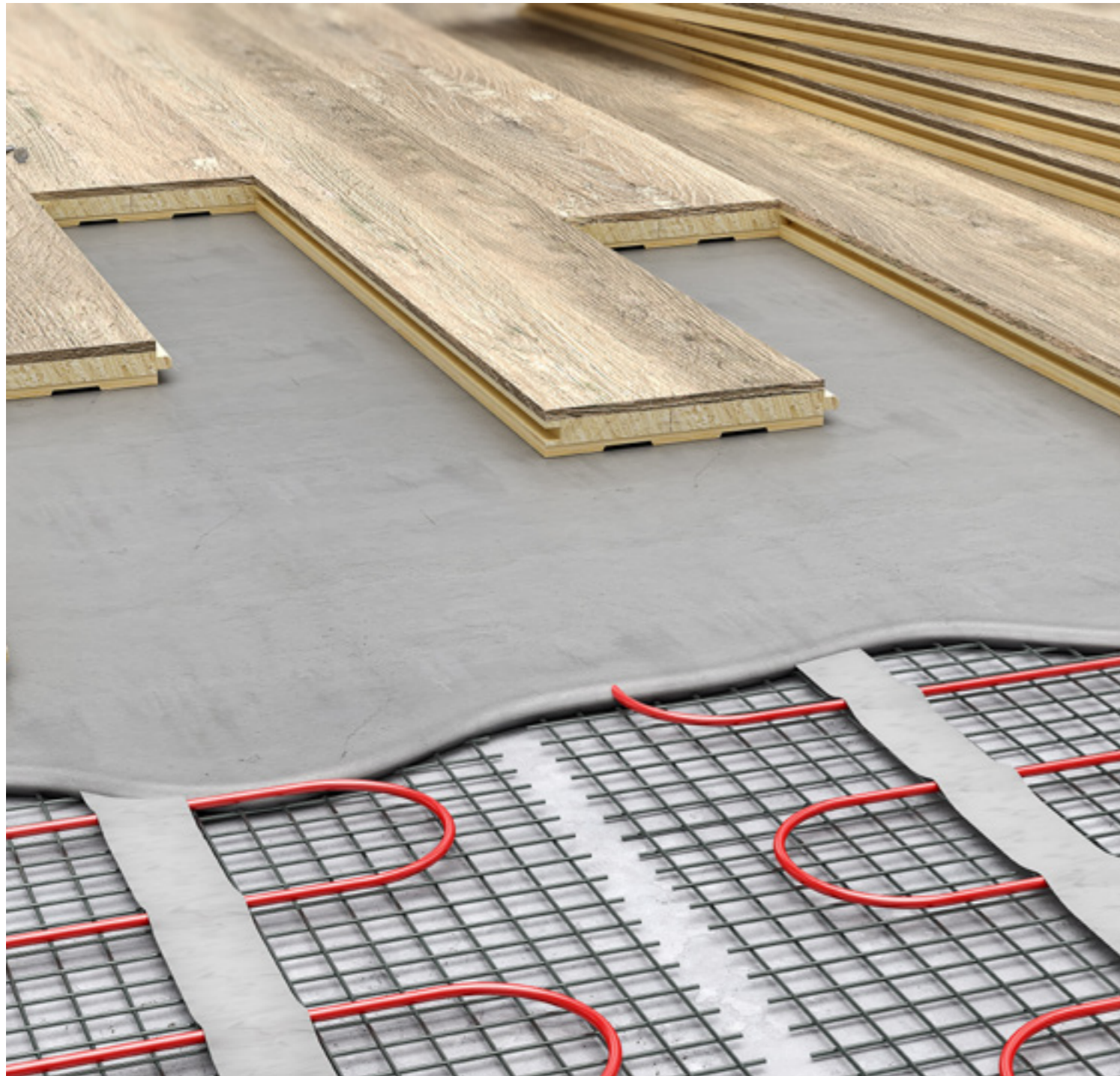

4.1

DESIGN REQUIREMENTS

- The underfloor heating system must be laid throughout the entire area that the timber flooring is to be installed (even if the heat demand does not justify it). If this is not possible, then it may be possible to separate the area while allowing for expansion. Contact Forté Customer Care for more information.
- Ensure the system is designed to minimise 'hot spots' by consistent spacing and height positioning of pipework/wires in the slab/screed of the entire underfloor heating system.
- There should be a probe located in each zone/room where there is underfloor heating to ensure accurate temperature readings and to regulate the surface temperature and that the probe is set so that it cannot exceed 27°C.
- When specifying electric underfloor heating systems set into screed, it is important that the subfloor beneath the heating system is prepared correctly for glue-down timber flooring. Please ensure that the underfloor heating contractor talks to the timber flooring installer prior to installation of the heating system.

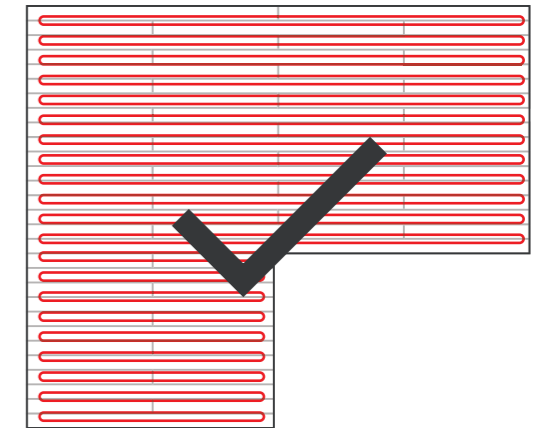

4.2

UNDERFLOOR HEATING SYSTEM COMPATIBILITY

Always ensure that the chosen underfloor heating system installer has proven experience of installation with timber flooring, and that the company supplying the system recommends installing under timber flooring with glue-down installation method.

The underfloor heating should be working at least 3 weeks before flooring is to be installed to allow enough time for commissioning and substrate preparation.

Systems	Approved	Max Temperature
Concrete floors with Hydronic Underfloor Heating system	✓	27
In-Screed Electric Underfloor Heating	✓	27
Electric Blanket Systems	✗	N/A
Hydronic with exposed water types	✗	N/A

4.2.1

CONCRETE FLOORS AND IN-SCREED WITH HYDRONIC UNDERFLOOR HEATING SYSTEM

The surface temperature of the timber flooring installed over a Hydronic Underfloor Heating System should never exceed 27°C.

The underfloor heating contractor should be engaged early on to ensure the system is setup to achieve this.

When commissioning the underfloor heating, increase the system in increments of 5°C until the system reaches 27°C,

keep the system at 27°C for at least 48 hours, then cool in increments of 5°C until the system reaches its lowest level.

- When installing a Hydronic system, the spacing (width) between the heating tubes should not be more than 150mm.
- The concrete slab surface is recommended to be 60mm above the heating tubes, with a minimum of 30mm.

4.2.2

IN-SCREED UNDERFLOOR HEATING SYSTEM

Once the flooring is installed, the concrete slab temperature when using an in-screed electric underfloor heating system, should never exceed 27 °C, and should ideally sit around 24 - 25°C. When commissioning the underfloor heating, increase the system in increments of 5°C until the system reaches 27°C,

keep the system at 27°C for at least 48 hours, then cool in increments of 5°C until the system reaches its lowest level.

The screed must be structurally sound and free from laitance, with the surface of the screed at least 8mm above the cables. Ensure the screed used is suitable for use with timber flooring.

4.2.3

OTHER UNDERFLOOR HEATING SYSTEMS

These systems are not designed to cope with the movement of a timber floor that is glued down, and the speed of sudden temperature changes with these systems can cause stability issues with your timber flooring, such as splitting, warping and cracking.

4.3

ADDITIONAL CARE & MAINTENANCE WITH UNDERFLOOR HEATING

Once the slab has been commissioned and is ready for installation, the underfloor heating should be turned on and increased in daily increments of 5°C until the installation surface temperature is 15°C. This temperature should be maintained and kept at 15°C until at least 48 hours after installation has been completed. For best performance, the heating system should be operating at all times, all year round to avoid the floor cooling and taking on moisture from the environment.

Large rugs or any object covering the flooring that is restricting heat dispersion from the system should be avoided. The 'accumulated' heat caused by these objects may lead to surface cracking, shrinkage/cupping, and coating breakdown of your timber flooring. When turning on and off underfloor heating it should always be turned up or turned down gradually using the 2°C per day,

If the underfloor heating does not run at a constant temperature all year round, more movement should be expected in the timber flooring, with gaps appearing and closing up from season to season.



Hillend Station House
Cordon Scott Architecture



Point Chevalier House
Sticks + Stones Design

5. Wet Areas (E3)

As of 5 November 2021, additional Building Code changes came into effect, which has impacted how wood flooring is to be specified in wet areas.

This change is only relevant to timber flooring being specified in wet areas such as kitchens, bathrooms, toilets, and laundries and does not include living areas, dining spaces, hallways, or entrances.

As Timber Flooring has been removed from Acceptable Solution E3/AS1, Timber flooring must now be submitted for Building Consent using one of the two below compliance pathways:

- Alternative Solution (D3 PVA Joints/Caulk Perimeter); or
- E3/AS2 (Wet Area Membrane)

Read this section for information about these options so you can decide which is best for your project.

5.1

SHOULD I SPECIFY AN ALTERNATIVE SOLUTION OR E3/AS2?

There are two compliance pathways to when specifying timber flooring in Wet Areas to comply with the E3 Building Code clause. Below is an overview of each, with guidance on which pathway to select;

Pathway 1: Alternative Solution (D3 PVA Joints/Caulk Perimeter)

Submit as an Alternative Solution by specifying Forté Timber flooring (all products have passed testing to ISO4760), sealing plank joints with D3 PVA, and sealing the perimeter with Caulking within the Wet Area.

Refer to [Forté Alternative Solution Guidance for Timber Flooring](#) for more information.

Pathway 2: E3/AS2 (Wet Area Membrane)

Submit under E3/AS2 by specifying a Wet Area Membrane in accordance with the Code of Practice for Internal Wet-area Membrane Systems. This is to be installed beneath the area the Timber Flooring is to be installed.

Refer to the [Code of Practice for Internal Wet-area Membrane Systems](#) for more information.

Where possible, it is recommended to specify an Alternative Solution (D3 PVA Joints/Caulk Perimeter) rather than a E3/AS2 (Wet Area Membrane).

The below table has been produced to provide general guidance on whether we recommend submitting the flooring as an Alternative Solution or not. Forté recommend using the Alternative solution, however a Wet Area Membrane can be used at all times.

5.1.1

CONSIDER THE BUILDING TYPE (OVERFLOW)

Multi-Dwelling Buildings (Residential and Commercial) require overflow to be considered in order to protect leaks from damaging adjoining properties.

E3/AS1 2.0.1 states that overflow is required when "...accidental overflow could damage an adjoining household unit or other property". When in effect, the overflow clause in E3/AS1 requires;

- Containment (coving of 75mm)
- Floor wastes (complying with NZBC G13).

As there are complications around the detailing of containment and floor wastes with Timber Flooring, we recommend the specifier adhere to the exemption under E3/AS1 2.0.2, which states,

"Household kitchen sinks and laundry tubs that have an integrated overflow with a minimum flow rate of 0.25 l/s do not require additional overflow provision..."

To satisfy this exemption, the specifier should ensure that:

- 1) Either the maximum flow rate from the inlet tap(s) is less than the flow rate of the integrated overflow for that sink or tub, or
- 2) The water supplies to the inlet tap(s) for that sink or tub are fitted with proprietary flow restrictors (such as cartridges) to limit the tap flow rate to less than the flow rate of the integrated overflow for the sink or tub.

Note: This does not apply to single (detached) dwellings

Building Type	Alternative Solution	E3/AS2
Single Dwelling	✓	✓
Multi Dwelling (flow rate of tap <u>less</u> than overflow rate of sink/tub)	✓	✓
Multi Dwelling (flow rate of tap <u>more</u> than overflow rate of sink/tub)	✗	✓

E3 SPECIFICATION FLOWCHART

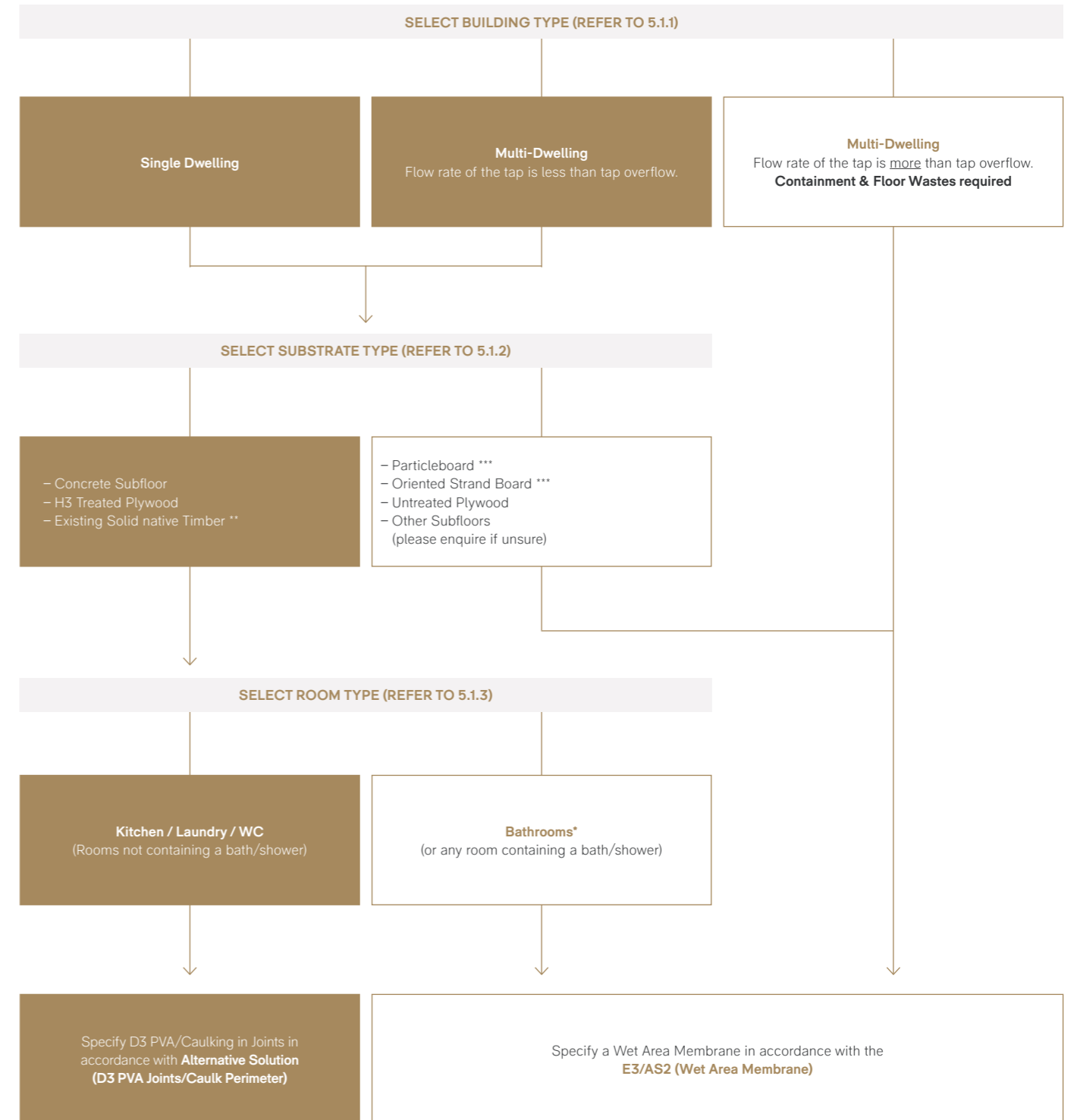

* **Bathrooms:** Forté does not recommend the installation of timber flooring in bathrooms (rooms with baths / showers)

** **Existing Solid Native Timber:** If subfloor is an existing Solid Native Timber, apply a 2-Component Epoxy Moisture Barrier to the subfloor before installation. This will provide additional protection to the structure in the case of a major floor/leaking.

*** **Particleboard & Oriented Strand Board:** Forté does not recommend the installation of Timber Flooring and Particleboard & Oriented Strand Board without a Wet Area Membrane, as the scope of use statement on the product Appraisal / Codemark for these products generally require a wet-area membrane to be installed for use in wet-areas.

5.1.2

CONSIDER THE SUBSTRATE/STRUCTURE OF THE WET AREA

The second point to consider is the substrate beneath the area of Timber Flooring within the Wet Area. The table below shows the common substrates with comments about their suitability for submission as an Alternative Solution or whether an E3/AS2 Wet Area Membrane is required.

Substrate		Alternative Solution	E3/AS2
Concrete (Slab-on-Grade or Suspended)	Concrete is deemed impervious by BRANZ and is a good substrate for the installation of Forté timber flooring.	✓	✓
H3 Treated Plywood	H3 Treated Plywood is the preferred substrate for installation over framed timber substructures. (Refer to 'Timber Subfloors and Assured Maintenance' in the Forté Alternative Solution Guidance for Timber Flooring)	✓	✓
H1.2 Solid Pinus	(Refer to 'Timber Subfloors and Assured Maintenance' in the Forté Alternative Solution Guidance for Timber Flooring)	✓	✓
Existing Solid Native Timber	(Refer to 'Timber Subfloors and Assured Maintenance' in the Forté Alternative Solution Guidance for Timber Flooring). If subfloor is an existing Solid Native Timber, apply a 2-Component Epoxy Moisture Barrier to the subfloor before installation. This will provide additional protection to the structure in the case of a major floor/leaking.	✓	✓
Particleboard / Oriented Strandboard	Forté does not recommend the installation of Timber Flooring over Particleboard & Oriented Strandboard without a Wet Area Membrane, as the scope of use statement on the product Appraisal/Codemark for these products generally require a wet-area membrane to be installed for use in wet-areas. Particleboard Note: Further to the above, the E3/AS2 solution states, "Particleboard must not be used as a new substrate in any wet area", and so should not be specified for use in any new construction in wet areas. For renovations with existing particleboard framed flooring, refer to point 4.1.3 of the Code of Practice for Internal Wet-area Membrane Systems for compliance pathway with sheet overlay prior to apply Membrane.	✗	✗
Untreated Plywood Other Subfloors	It may be possible to install Forté timber flooring directly to some Fiber Cement compressed sheet types, please enquire for more information. For untreated plywood and any other subfloor type, we would generally recommend installing over the top of a Wet Area Membrane in accordance with E3/AS2 (provided it is suitable). Please enquire for more information.	✗	?

5.1.3

CONSIDER BATHROOMS (ROOMS WITH A BATH/SHOWER) VS. WATERSPLASH AREAS

Although it is possible, Forté does not recommend the installation of timber flooring in bathrooms (rooms with baths/ showers), and installations in these areas are outside the Alternative Solution guidance.

Please contact Forté if you have an area requiring installation in one of these areas for project-specific information.

5.2

ALTERNATIVE SOLUTION (INSTALL WITH D3 PVA/CAULKING IN JOINTS)

Refer to the [Forté Alternative Solution Guidance for Timber Flooring Document](#) for more information.

5.2.2

SCOPE OF USE

This Alternative Solution applies to

- Single-dwelling kitchens / Laundries / WC (Excludes bathrooms – refer to 5.1.3)
- Multi-dwelling kitchens/laundries (where flow rate of the tap is less than tap overflow)

5.2.3

REQUIRED FOR COMPLIANCE

- Forté Timber Flooring installed in accordance with Timber Flooring Overlay System Installation Guide
 - Water-resistant D3 PVA applied to all joints during installation (within 1.5m of Sanitary Fixture/Appliance)
 - Water-resistant caulking silicone gap filler applied to seal around the perimeter as well as any fixed items in the room/area (within 1.5m of Sanitary Fixture/Appliance)
- Forté Timber Flooring, which has passed an E3 Moisture Test (all flooring products have passed)
- [If subfloor is an existing Solid Native Timber] Apply a 2-Component Epoxy Moisture Barrier to the subfloor before installation.

5.2.4

HOW TO SUBMIT ALTERNATIVE SOLUTION

MASTERSPEC

Forté have updated their work section on Masterspec (refer to 6311FF Forté Timber Overlay System) with all the required documentation to specify timber flooring in accordance with E3 requirements.

OTHER

Our team are able to put together a specification for you using our MasterSpec account if you do not use Masterspec. Otherwise, if you require a customised solution, please contact your Forté representative.

Note: Refer to '3.3 Flooring Buildup Diagrams' for a link to the documents required to submit to council.

5.3

INSTALL OVER A WET AREA MEMBRANE (E3/AS2)

The Waterproofing Membrane Association Incorporated have developed a Code of Practice as a guide for installing Wet-area Membranes in accordance with E3/AS2. This Code of Practice for Internal Wet-area Membrane Systems should be used in conjunction with the Forté Timber Overlay Flooring Installation Guide for installations over top of Wet-area Membrane Systems.

Note: The E3/AS2 solution states, "Particleboard must not be used as a new substrate in any wet area", and so should not be specified for use in any new construction in wet areas.

For renovations with existing particleboard framed flooring, refer to point 4.1.3 of the Code of Practice for Internal Wet-area Membrane Systems for compliance pathway with sheet overlay prior to applying the Membrane.

5.3.1

SYSTEMS APPROVED FOR USE WITH FORTÉ TIMBER FLOORING

Forté have worked with wet-area membrane suppliers to ensure there is a suitable membrane available for use with all of our products. The two systems we commonly recommend are:

- 1) [Ardex WPM002](#)
- 2) [Mapei Aqua Defense](#)

5.3.2

WATER-STOPS/TRANSITIONS (E3/AS2 4.5.1, 4.5.2, 4.5.5)

For ease of use, please see specific sections below relating to the transitions as noted in the [Code of Practice for Wet-area Membrane Systems](#):

- 1) Water-stop at termination of waterproof membrane system
 - a) Open Plan area: Refer to Figure 14
 - b) Under Door: Refer to Figures 18/19/20
- 2) Cabinetry Water-stops
 - a) Membrane installed before/under cabinetry: Refer to Figures 15/16 (Recommended)
 - b) Membrane installed after cabinetry installation: Refer to Figure 17 (Not Recommended)
- 3) Floor-to-wall Junction: Refer to Figure 21
- 4) Penetrations for Piped Services: Refer to Figures 27/28

5.3.3

WET AREA MEMBRANES IN KITCHENS

When installing Wet-Area membranes it is strongly recommended that the timber flooring is installed beneath the entire kitchen area.

This is because the membrane must extend 75mm up the wall, and if the kitchen is installed prior to the flooring, then the Code of Practice recommendation is that the membrane must extend 75mm up the cabinetry toe kicks, and this can cause aesthetic issues.

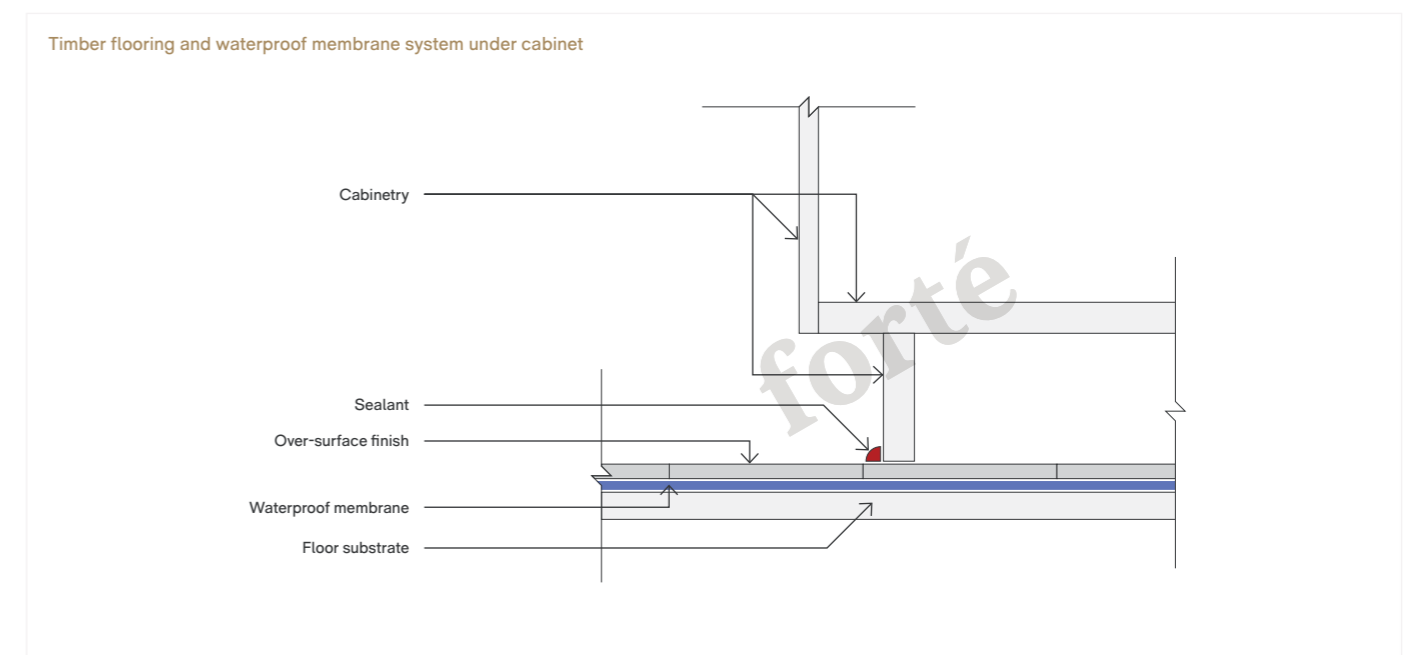
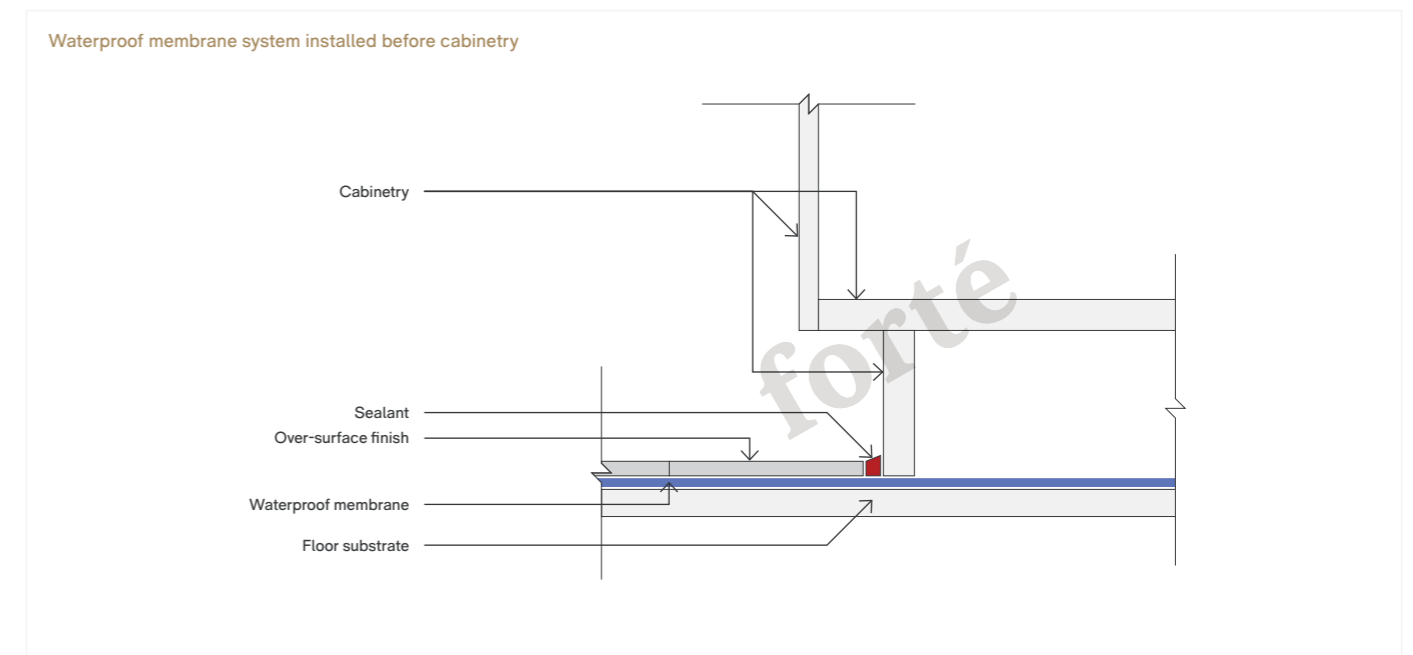

6. Stairway Design and Access (D1)

6.1

STAIRWAY DESIGN OVERVIEW

Stairway Design Overview

Stairway Type	Accessible Stairway	Common Stairway	Service Stairway	Private Stairway			
				Main Private	Secondary Private	Minor Private	
Design	Reference Note	Refer to D1/AS1 'Definitions' for examples		Includes: Private houses, private apartments, and small industrial buildings			
Max Pitch	D1/AS1, Table 6	32°	37°	47°	37°	41°	47°
Max Riser Height	D1/AS1, Table 6	180mm	190mm	220mm	190mm	200mm	220mm
Min Tread Depth	D1/AS1, Table 6	310mm	280mm	220mm	280mm	250mm	220mm
Min Stairway Width	D1/AS1, 4.2.1	900mm	850mm	850mm	850mm	850mm	850mm

6.2

FORTÉ STANDARD NOSING DESIGN & APPLICATIONS

Forté 3-in-1 stair nosing

Suitable for: Private (Residential), Common, and Service Stairways

Our standard nosing is for low-medium traffic stairways. The leading edge has a 1-2mm aris which provides some level of protection from chipping. The premium nosing is recommended for high-traffic stairways.

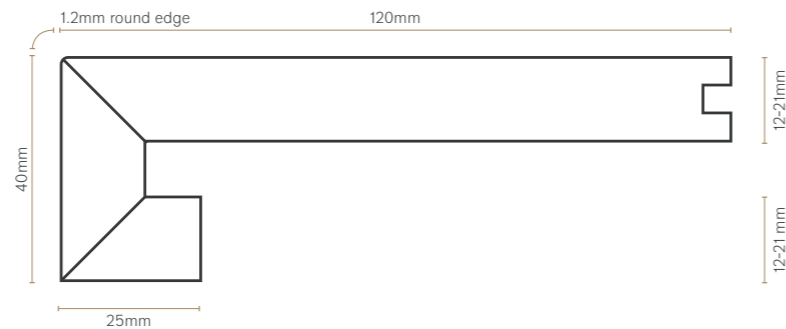

Applications

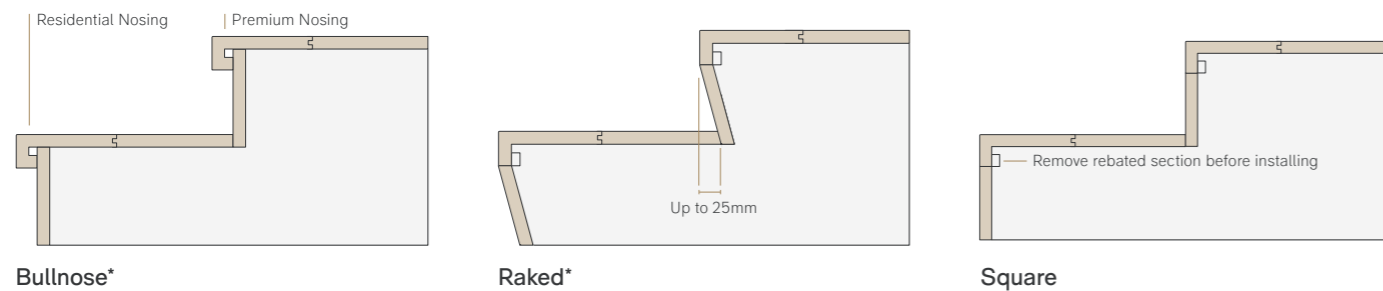

Bullnose*

Raked*

Square

*The building code allows a 25mm protrusion of the nosing. This allows the total stair depth to be reduced, thus saving space and cost.

For example, a 2.5m high staircase with 14 nosings will reduce the overall staircase length by 350mm.

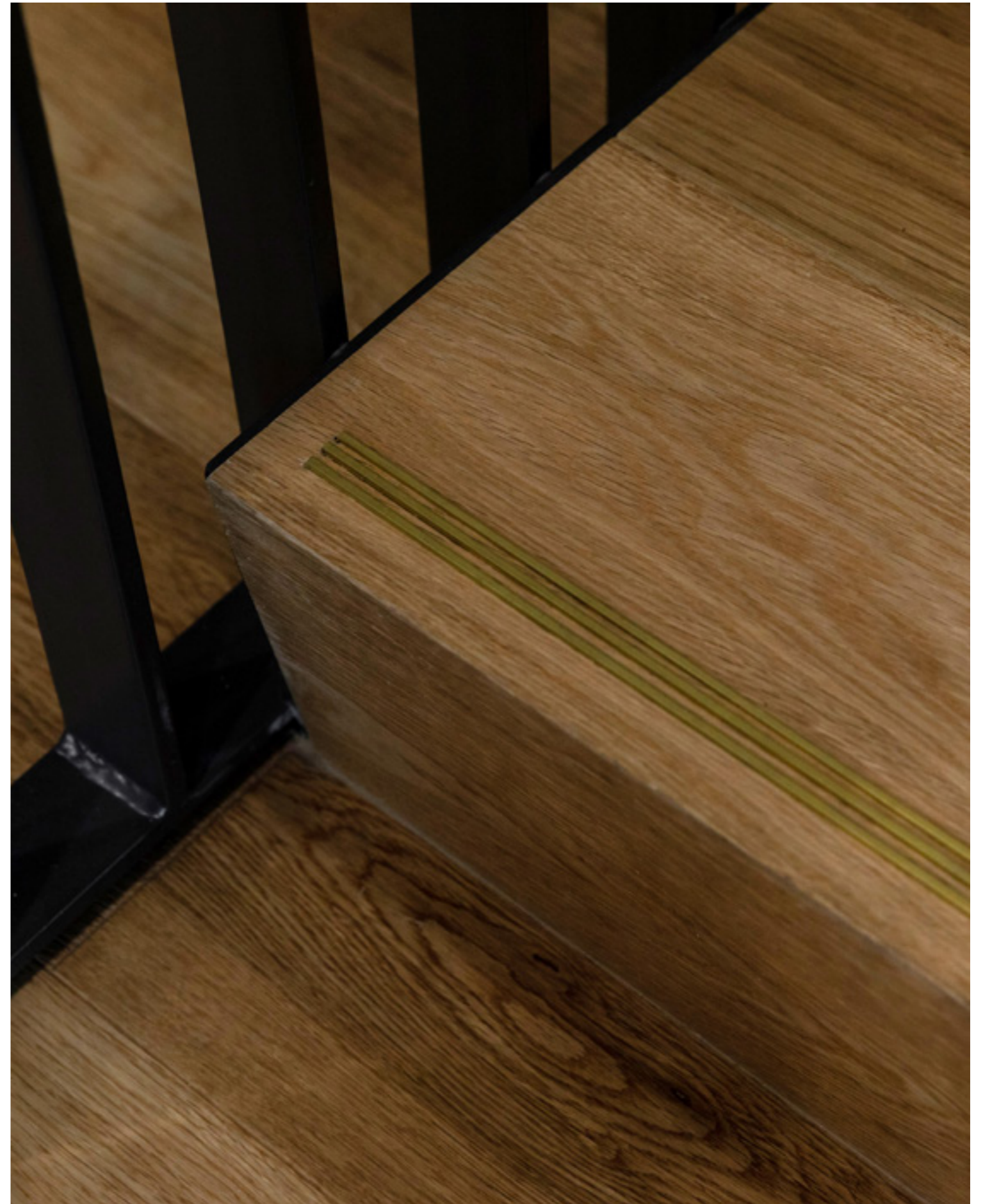

6.3

FORTÉ PREMIUM NOSING DESIGN & APPLICATIONS

Forté Premium Stair Nosing

Suitable for: Private (Residential), Common, and Service Stairways

Our Premium nosing has a brass profile inserted to the leading edge of the nosing to provide additional protection and a premium aesthetic.

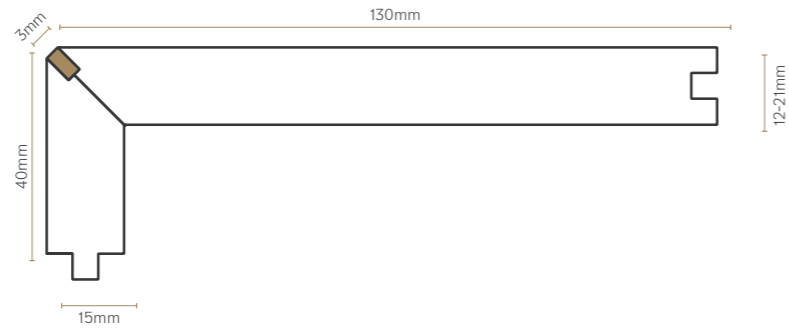

Applications

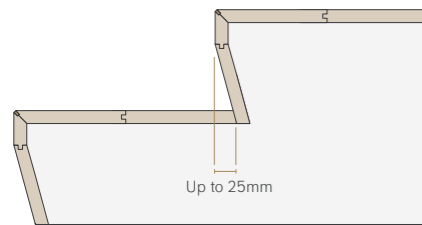

Raked*

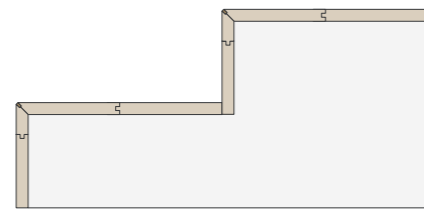

Square

6.4

FORTÉ ACCESSIBLE NOSING DESIGN & APPLICATIONS

Forté Accessible Stair Nosing

Must be used for Accessible stairways, may also be used for all other Stairways

Our Accessible nosing is designed as a solution to comply with all NZBC requirements for Accessible Stairways. To achieve an LRV contrast of 30, all Accessible nosings have an anodised silver trim. The leading edge of the nosing also has a 5mm quarter round inserted to achieve NZBC requirements.

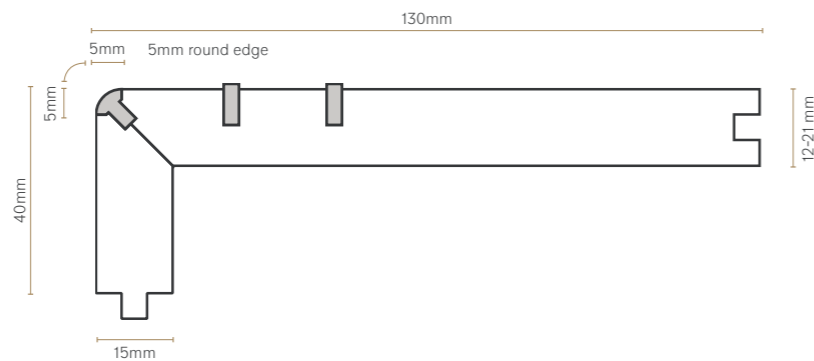

Applications

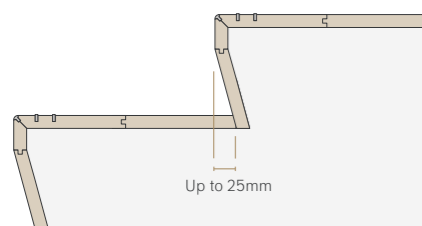

Raked Accessible

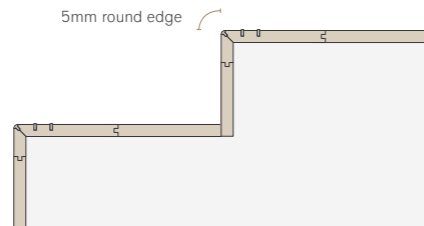

Square Accessible

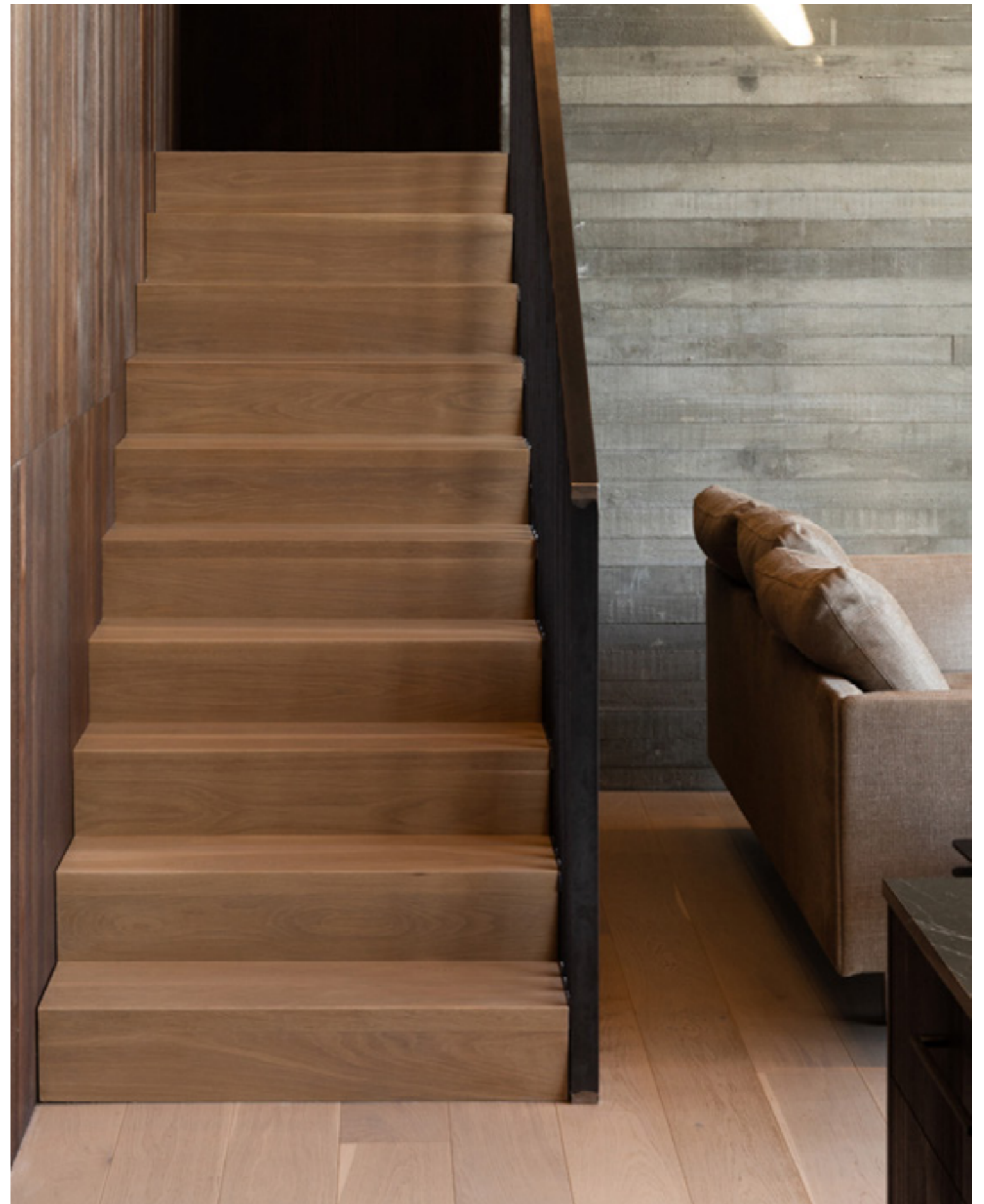

Stair Nosing Codes					
Collection	Colour	Standard Nosing	Premium Nosing	Accessible Nosing	Length
Artefact	Ammonite	SN-ARTAMM-S	SN-ARTAMM-P	SN-ARTAMM-A	1980
	Amulet	SN-ARTAMU-S	SN-ARTAMU-P	SN-ARTAMU-A	1980
	Flint	SN-ARTFL-S	SN-ARTFL-P	SN-ARTFL-A	1980
	Obsidian	SN-ARTO-S	SN-ARTO-P	SN-ARTO-A	1980
Artiste Grande	Da Vinci	SN-AGDV-S	SN-AGDV-P	SN-AGDV-A	2480
	Picasso	SN-AGP-S	SN-AGP-P	SN-AGP-A	2480
	Van Gogh	SN-AGV-S	SN-AGV-P	SN-AGV-A	2480
	Vermeer	SN-AGVG-S	SN-AGVG-P	SN-AGVG-A	2480
Atelier	Classic 15mm	SN-ATC15-S	SN-ATC15-P	SN-ATC15-A	2180
	Classic 21mm	SN-ATC21-S	SN-ATC21-P	SN-ATC21-A	2180
	Dolomite 15mm	SN-ATD15-S	SN-ATD15-P	SN-ATD15-A	2180
	Dolomite 21mm	SN-ATD21-S	SN-ATD21-P	SN-ATD21-A	2180
	Granite 15mm	SN-ATG15-S	SN-ATG15-P	SN-ATG15-A	2180
	Granite 21mm	SN-ATG21-S	SN-ATG21-P	SN-ATG21-A	2180
	Marl 15mm	SN-ATM15-S	SN-ATM15-P	SN-ATM15-A	2180
	Marl 21mm	SN-ATM21-S	SN-ATM21-P	SN-ATM21-A	2180
	Siltstone 15mm	SN-ATS15-S	SN-ATS15-P	SN-ATS15-A	2180
	Siltstone 21mm	SN-ATS21-S	SN-ATS21-P	SN-ATS21-A	2180
Indus	Atacama	SN-INA-S	SN-INA-P	SN-INA-A	2380
	Colorado	SN-INC-S	SN-INC-P	SN-INC-A	2380
	Kharan	SN-INK-S	SN-INK-P	SN-INK-A	2380
	Mojave	SN-INM-S	SN-INM-P	SN-INM-A	2380
	Patagonia	SN-INP-S	SN-INP-P	SN-INP-A	2380
	Sahara	SN-INS-S	SN-INS-P	SN-INS-A	2380
	Tanami	SN-INT-S	SN-INT-P	SN-INT-A	2380
Loft	Astoria	SN-LOA-S	SN-LOA-P	SN-LOA-A	1810
	Brooklyn	SN-LOB-S	SN-LOB-P	SN-LOB-A	1810
	Brighton	SN-LOBT-S	SN-LOBT-P	SN-LOBT-A	1810
	Claremont	SN-LOC-S	SN-LOC-P	SN-LOC-A	1810
	Harlem	SN-LOH-S	SN-LOH-P	SN-LOH-A	1810
	Manhattan	SN-LOM-S	SN-LOM-P	SN-LOM-A	1810
	Stamford	SN-LOS-S	SN-LOS-P	SN-LOS-A	1810
	Soho	SN-LOSF-S	SN-LOSF-P	SN-LOSF-A	1810
	Tribeca	SN-LOT-S	SN-LOT-P	SN-LOT-A	1810

Collection	Colour	Standard Nosing	Premium Nosing	Accessible Nosing	Length
Moda Vita	Amalfi	SN-MOVA-S	SN-MOVA-P	SN-MOVA-A	2180
	Capri	SN-MOVC-S	SN-MOVC-P	SN-MOVC-A	2180
	Como	SN-MOVCA-S	SN-MOVCA-P	SN-MOVCA-A	2180
	Dolcedo	SN-MOVD-S	SN-MOVD-P	SN-MOVD-A	2180
	Isola	SN-MOVI-S	SN-MOVI-P	SN-MOVI-A	2180
	Mondello	SN-MOVM-S	SN-MOVM-P	SN-MOVM-A	2180
	Sorrento	SN-MOVS-S	SN-MOVS-P	SN-MOVS-A	2180
	Tuscany	SN-MOVT-S	SN-MOVT-P	SN-MOVT-A	2180
	Verona	SN-MOVV-S	SN-MOVV-P	SN-MOVV-A	2180
	Smartfloor	Blond	SN-SBO-S	SN-SBO-P	SN-SBO-A
Clay		SN-SCO-S	SN-SCO-P	SN-SCO-A	2180
Marron		SN-SMO-S	SN-SMO-P	SN-SMO-A	2180
Natural		SN-SNO-S	SN-SNO-P	SN-SNO-A	2180
Sandstone		SN-SSO-S	SN-SSO-P	SN-SSO-A	2180
Tawny		SN-STO-S	SN-STO-P	SN-STO-A	2180
Ultra		Natural	SN-ULN-S	SN-ULN-P	SN-ULN-A
	Driftwood	SN-ULD-S	SN-ULD-P	SN-ULD-A	1880
	Marron	SN-ULMA-S	SN-ULMA-P	SN-ULMA-A	1880
	Mink Grey	SN-ULMG-S	SN-ULMG-P	SN-ULMG-A	1880
	Marbled	SN-ULM-S	SN-ULM-P	SN-ULM-A	1880
	Tussock	SN-ULT-S	SN-ULT-P	SN-ULT-A	1880
	Urban	Barcelona	SN-URBA-S	SN-URBA-P	SN-URBA-A
Berlin		SN-URBE-S	SN-URBE-P	SN-URBE-A	1810
Copenhagen		SN-URC-S	SN-URC-P	SN-URC-A	1810
Milan		SN-URM-S	SN-URM-P	SN-URM-A	1810
New York		SN-URNY-S	SN-URNY-P	SN-URNY-A	1810
Oslo		SN-URO-S	SN-URO-P	SN-URO-A	1810
Prague		SN-URP-S	SN-URP-P	SN-URP-A	1810
Seoul		SN-URS-S	SN-URS-P	SN-URS-A	1810
Tokyo		SN-URT-S	SN-URT-P	SN-URT-A	1810
Villa		Cashmere	SN-VIC-S	SN-VIC-P	SN-VIC-A
	Dune	SN-VID-S	SN-VID-P	SN-VID-A	2380
	Limestone	SN-VIL-S	SN-VIL-P	SN-VIL-A	2380
	Raven	SN-VIR-S	SN-VIR-P	SN-VIR-A	2380
	Russet	SN-VIRU-S	SN-VIRU-P	SN-VIRU-A	2380

6.4

SLIP RESISTANCE

As per 2.1.5b of D1/AS1, Handbook HB197 can be used to advise on minimum slip resistance values for various areas based on the Wet Pendulum test conducted as per AS4586 using a slider 96 rubber.

Wet Pendulum Slip Resistant Value (SRV) to HB197 Classification

SRV (slider 96)	Classification	Slip-Resistant Nosings Required?
<12	Z	
12—24	Z	Yes
25—34	Y	
35—44	X	
45—54	W	No
>54	V	

More Slip Resistant
↓

The required result for stairways (provided handrails are present) is Classification X.

HB197:1999 Table 1 – Flooring selection pendulum recommendations for specific locations (Extract)

Location	Required Pendulum Result
Accessible internal stair nosings (dry areas)- handrails present	Classification X

6.4.1

STAIRWAYS

As per the below table, all Forté collections achieve a Classification X or W and therefore are suitable for use on stairways (both residential and commercial) without slip-resistant nosings provided handrails are present.

If handrails are not present, or if you would like additional slip-resistance, it is possible to create slip-resistant nosing as per the below guidelines.

D1 Access — Stairs / Ramps

Collection	SRV Result (AS4586)	Classification (HB197)	P Rating	Slip Resistant Nosings
Loft	42	X	P3	Not Required
Urban	46	W	P4	Not Required
Moda Vita	43	X	P3	Not Required
Smartfloor	41	X	P3	Not Required
Indus	40	X	P3	Not Required
Atelier	31	Y	P2	Slip Resistant Nosings Required
Ultra	38	X	P3	Not Required
Artefact	42	X	P3	Not Required
Villa	40	X	P3	Not Required
Artiste Grande	42	X	P3	Not Required

6.4.2

RAMPS

The maximum acceptable slopes for ramps are given in below table. The choice of slope must take account of the type of use and risk of slipping.

Accessible ramps must have an upstand of no less than 75mm in height on any drop-off side of a ramp and the clear width of an accessible ramp must be 1200mm.

As mentioned in the above table, all Forté collections have achieved a P3 rating (1:10), with the exception of the Atelier collections which has a P2 rating (1:12).

Acceptable Ramp Slopes

Type of Ramp	Maximum Slope
Accessible ramp	1:12
Common ramp subject to wetting	1:10
Common ramp normally dry	1:8
Service ramps	1:3

6.5

COMMERCIAL ENTRANCES

Entrance mats should always be incorporated into the main entrance points in commercial spaces to minimise water and stones damaging the timber floor (required as per 2.1.6 'Transition Zones' of D1/AS1).

If the entrance mat is inset to the timber flooring, we recommend an aluminium or brass flat bar to be installed around the perimeter to protect the edge of the timber. These are available to purchase from Forté.

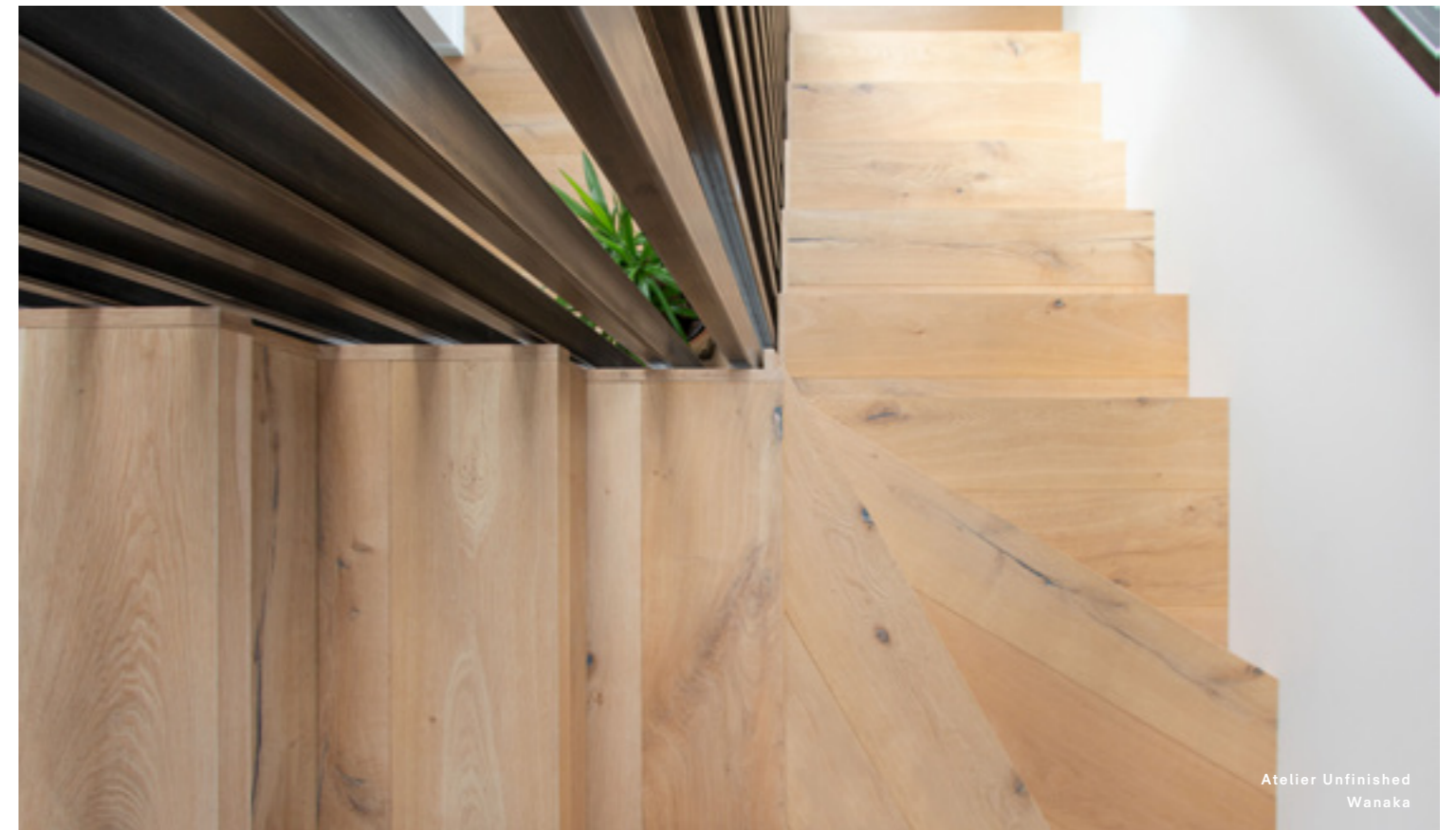

Atelier Unfinished
Wanaka



Forté Auckland Experience Centre
Wonder

7. Flooring Heights & Finishings

7.1 FLOORING HEIGHT

If there is a major variance of height within the subfloor where the timber flooring is to be installed, ie. a renovation, plywood sheets/squares can be used to level this out to achieve a flush transition prior to installation.

For a minor variance of height within the subfloor where the timber flooring is to be installed, screed or levelling compound can be used to level this out prior to installation.

Note: As a general rule, the total finished height of the flooring on top of the substrate is the thickness of the product plus 2mm for glue and moisture barriers.

Where possible, consult with the flooring installer for site specific advice.

TRIMS & TRANSITIONS

Forté offer a range of flat bars, including unfinished, organic and anodised aluminium flat bar options. Refer to our [website](#) for all options and availability or enquire with your Forté Account Manager for more information.

Flooring Trim Overview

Profile	Uses	Finish	Colour	Code	Dimensions	Availability	
Transition Flat Bar The transition flat bar can be used to protect the edge of the timber with Carpet transitions. We have a range of finishes available, and recommend to select a colour that best complements the colour scheme.	7.2 Timber to Carpet 7.3 Timber to Timber	Anodised Aluminium	Silver	TFB-SA12	12mm x 3mm x 2.5m L	Stocked	
			Black	TFB-BA12	12mm x 3mm x 2.5m L	Stocked	
			Champagne	TFB-CA12	12mm x 3mm x 2.5m L	Stocked	
			Light Bronze	TFB-LBA12	12mm x 3mm x 2.5m L	Stocked	
			Dark Bronze	TFB-DBA12	12mm x 3mm x 2.5m L	Stocked	
	Organic			Brass	TFB-OB13	3.175mm x 12.7mm x 3.6m L	Stocked
					TFB-OB19	3.175mm x 19mm x 3.6m L	Stocked
				Aged Brass	TFB-AB13	3.2mm x 12.7mm x 3.6m L	Custom Order
				Waxed Steel	TFB-WS13	13mm x 3mm x 4m L	Stocked
Joinery Angle Trim For a seamless finish, we recommend the Joinery Angle Trim to be specified to match the Joinery colour. Forté can supply the unfinished trim to the installer to achieve this. Alternatively, we stock Silver and Black Anodised trims.	7.6 Timber to Joinery	Aluminium	Raw	JAT-UA13	13mm x 14mm x 2.5m L	Stocked	
			Anodised Aluminium	Silver	JAT-SA13	13mm x 14mm x 2.5m L	Stocked
				Black	JAT-BA13	13mm x 14mm x 2.5m L	Stocked
Tile Angle Trim	7.4 Timber to Tile	Forté does not sell tile trims and we generally recommend the Tilers Mate L-Angle Tile Trim. The trim should be selected based on the selected tile thickness. For a list of sizes available visit: https://www.tilersmate.co.nz/product/anodised-l-profile-tile-trim/ For a list of Stockists visit: https://www.tilersmate.co.nz/stockist/					

Transition Ramp 7.5 Timber to Polished Concrete
Matching Ramps are available on custom order from Forté.



Transition Flat Bar

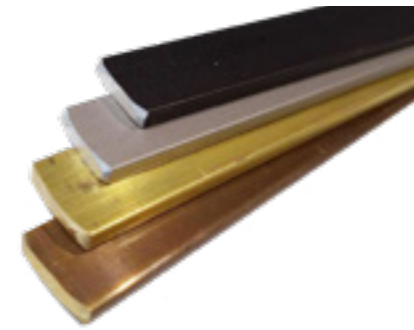

Joinery Angle Trim



Tile Angle Trim

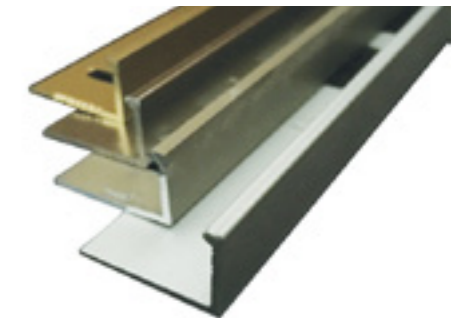

7.1.2

CAULKING

Caulking Overview

Availability	Stocked	Uses	7.6 Timber to Joinery	7.7 Timber to Front Door	7.8 Skirtings 5.2 E3	5.2 E3 Alternative Solution
Brand	Colour	Code	Matching Forté Product			
Aquaseal Flexfill	Afrosia	CA-ASA	Artiste Grande: Vermeer		Indus: Patagonia, Tanami	
			Smartfloor: Marron Oak		Urban: Oslo	
			Ultra: Marron Oak			
Bona Gap Master	Light Oak	CA-BOOL	Smartfloor: Natural Oak		Urban: New York	
	Dark Oak	CA-BOOD	Indus: Mojave		Moda Altro, Stretto: Sorrento	
			Ultra: Bordeaux Oak , Champagne Oa		Urban: Prague	
			Villa: Chai			
	Wenge	CA-BOWE	Artefact: Obsidian		Moda Altro, Stretto: Dolcedo, Isola	
Urban: Tokyo						
HB Fuller Caulk in Colours	Black	CA-BOB	Urban: Seoul		Villa: Raven	
			Atelier: Marl Indus: Kharan		Moda Altro, Stretto: Capri, Mondello	
			Smartfloor: Clay Oak		Urban: Berlin, Copenhagen	
Villa: Dune, Limestone						
Mocca	CA-FLM	Artiste Rustic: Da Vinci		Atelier: Classic, Siltstone		
		Ultra: Tussock				
		Urban: Milan				
Selleys No More Gaps	Ivory	CA-SEI	Ultra: Marbled Oak		Moda Altro, Stretto: Amalfi	
			Villa: Cashmere		Smartfloor: Blond Oak	
	Coffee	CA-SEC	Artiste Rustic: Picasso, Van Gogh		Atelier: Granite	
			Indus: Atacama , Colorado, Sahara		Moda Altro, Stretto: Como, Tuscany, Verona	
			Smartfloor: Sandstone Oak, Tawny Oak,		Urban: Barcelona	
Ultra: Driftwood, Grey Mink				Villa: Flint, Ammonite, Amulet		



7.2 TIMBER TO CARPET

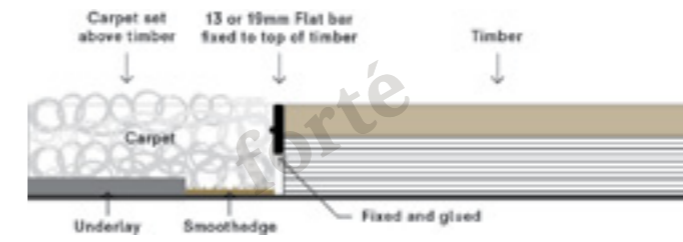

Generally the carpet should be set as little higher above the timber to start with, as it will settle over time to be flush with the timber flooring. If required, you can install an MDF ramp beneath the carpet to smooth any difference in heights (e.g. <https://giltedge.co.nz/product/ramp-edge-5mm>)

TRANSITION WITH INSERT (RECOMMENDED)

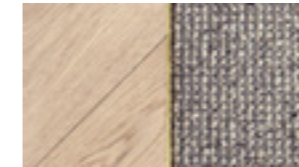

Design requirements: The top of the flat bar should be set level with the top of flooring.

We recommend transitioning from carpet to timber using an extruded Flat Bar (Brass / Aluminium are often used) inserted into the flooring. When the flat bar is installed along the edge of the timber it creates a protective edge for the wood which reduces the risk of damage and provides a quality finish.

TRANSITION WITH NO INSERT (NOT RECOMMENDED)



Design requirements: The pile of the carpet should be set a little higher above the timber floor as the carpet pile will settle and potentially leave the timber edge exposed without protection.

It is also possible to transition to carpet with no flat bar, however it becomes even more important to set the carpet height correctly as when the carpet settles, the edge of the timber has no protection, and may chip off if heavy objects are dragged across the transition.

7.3 TIMBER TO TIMBER (BORDER OR FLOORING DIRECTION CHANGE)

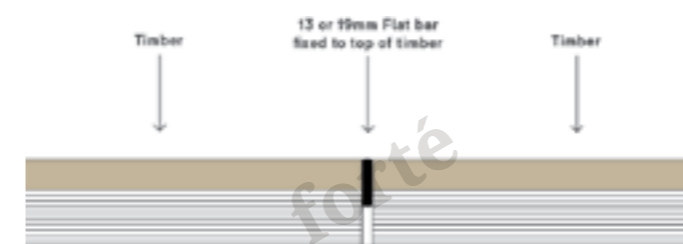

Timber to timber transitions are commonly found with borders around the perimeter of rooms installed with herringbone and chevron flooring or when the room changes direction and a break in the floor is needed to allow the flooring to continue to run along the length of the room.

For transitions using an insert, we recommend using an extruded Flat Bar for the most quality finish and appearance.

TRANSITION WITH INSERT

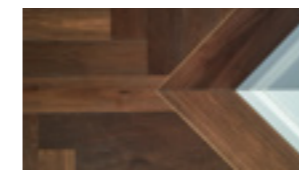

Design requirements: The bar should be fixed to the transition edge with screws with the top of bar set level with the top of the flooring.

TRANSITION WITH NO INSERT



Design requirements: If you are not planning to use an extruded flat bar when adding a border or creating a break in your flooring, then where possible a T&G profile should be used to join the boards together. Sometimes this is not possible (where the profile has been removed)

7.4

TIMBER TO TILE

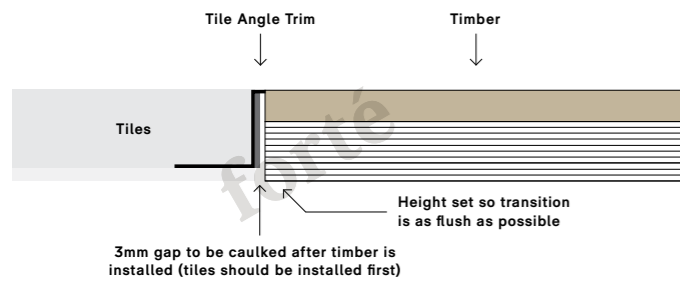

While flat bars are often used for other applications, transitions between timber and tiles should use a tile bar which is attached directly to the tile (not the timber).

Note: The height of the transition should be considered prior to installation.

TRANSITION WITH TILE BAR AND SILICONE (RECOMMENDED)

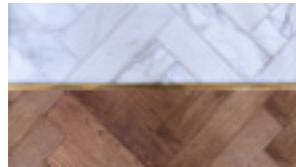

Design requirements: The tile bar is attached directly to the tile (not the wooden plank) and must be installed by the tiler prior to the wood floor being laid. When installing the timber, it should finish 2-3mm from the tile bar (to allow for expansion).

The silicone colour should match the colour of the flooring or the tile bar for ideal aesthetics. The tile bar colour should be selected to best match the space (black/silver/brass etc.)

ALTERNATIVE METHOD



Design requirements: The tiles should be installed before the timber. As mentioned above, when installing the timber, it should finish 2-3mm from the tiles (to allow for expansion) and the gap should be finished with silicone. The silicone colour should match the colour of the flooring or tile grout for ideal aesthetics. This is ideal for a curved transition or where a transition bar does not look good aesthetically.

The transition is finished with silicone only to look like grout.

7.5

TIMBER TO POLISHED CONCRETE / GARAGE FLOOR

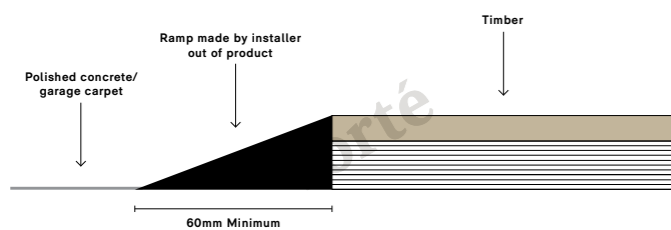

When transitioning from timber to a polished concrete floor (or garage carpet), it is important to remember that there may be a substantial height difference as the timber is glued to the concrete that it is transitioning to.



Design requirements: Experienced installers can make a ramp from the product being installed for a perfect colour match. Where possible, ramp down in an inconspicuous place like a doorway.

7.6

TIMBER TO JOINERY

Forté offer unfinished aluminium angle trims as well as silver and black adonised options. Angle trims are usually supplied unfinished and then powder coated by the contractor to match the joinery colour.

Refer to our [website](#) for all angle trim options and availability or enquire with your Forté Account Manager for more information.

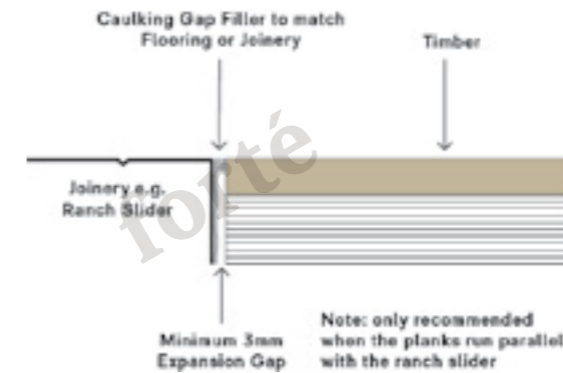
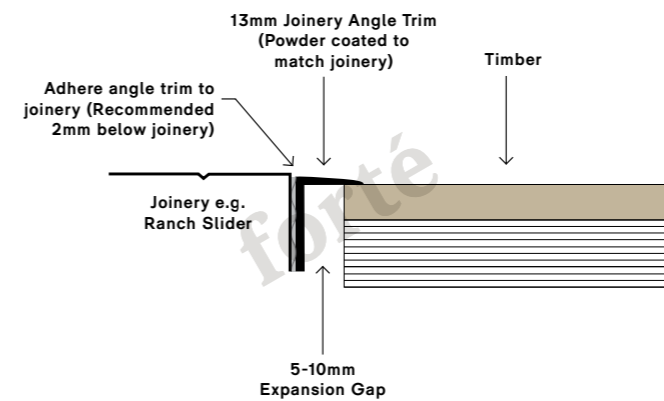

7.6.1

RANCH SLIDER WITH ANGLE TRIM

If the flooring level is higher or lower than the ranch slider threshold, then a 13mm angle trim will be necessary to protect the flooring edges from wear and tear. The angle trim will need to be glued/taped to joinery.

Design requirements: Use a slim 13mm aluminium angle trim that is powder-coated to match the colour of the aluminium joinery.

7.7

TIMBER TO FRONT DOOR

Timber to timber transitions are commonly found with borders around the perimeter of rooms installed with herringbone and chevron flooring or when the room changes direction and a break in the floor is needed to allow the flooring to continue to run along the length of the room.

For transitions using an insert, we recommend using an extruded Flat Bar for the most quality finish and appearance.

FRONT DOOR WITH TIMBER SILL REMOVED (RECOMMENDED)



Design requirements: The wood floor will need to be installed leaving a 2–3mm gap between the adjoining surfaces and finished off with a coloured caulking that matches your flooring.

FRONT DOOR WITH TIMBER SILL



Design requirements: Timber should finish 2–3mm from the sill and gap should be finished with silicone/caulking gun. Silicone colour should match colour of flooring or sill for ideal aesthetics. Paint the Sill to match flooring or skirtings.

7.8

SKIRTINGS

We recommend an 18mm skirting board to accommodate for expansion gap around perimeter.

7.8.1

FLOOR TO WALL WITH SKIRTING

FLOOR TO WALL WITH SKIRTING

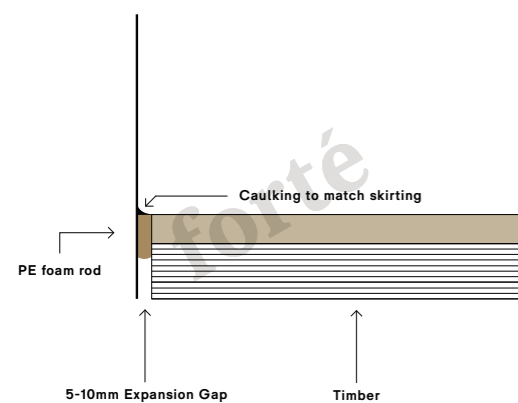

FLOOR TO WALL WITHOUT SKIRTING

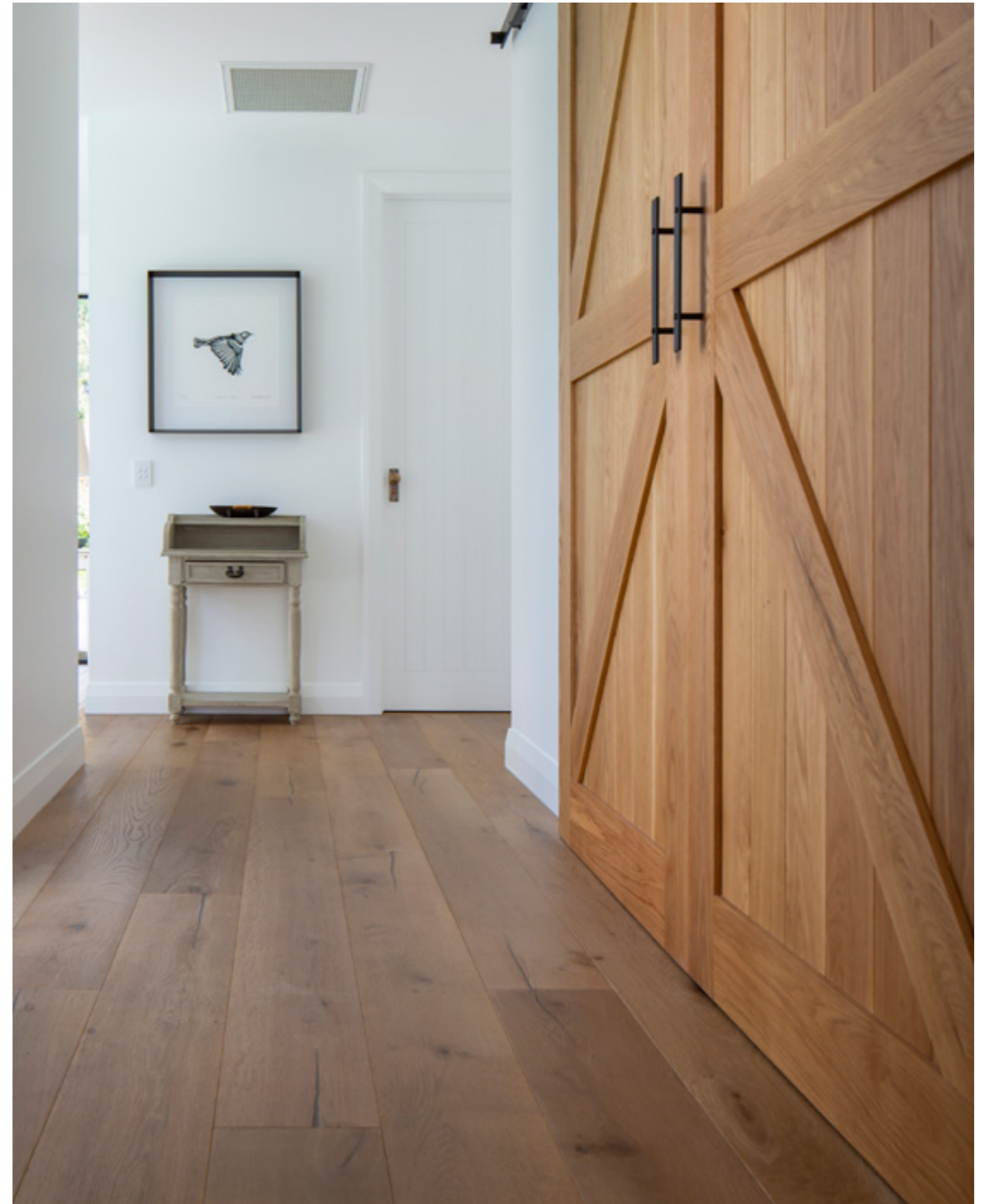
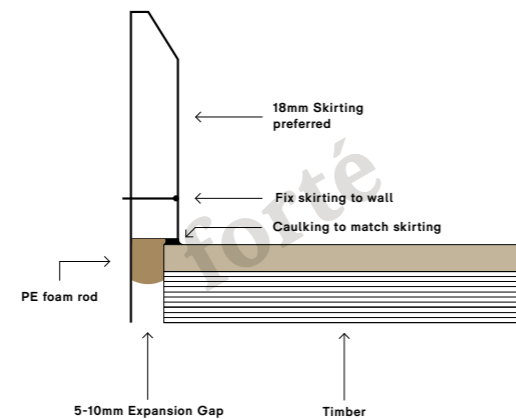



Top Notch
Jack McKinney Architecture

8. Energy Efficiency (H1)

8.1 UNDERFLOOR HEATING CONSIDERATIONS

Timber's R-value refers to its ability to resist thermal conductivity. Higher R-values equate to better insulation; materials with large R-values keep heat from escaping the home during the winter and permeating it during the summer. 0.11-0.15m² K/W is an ideal range of r-value for use with underfloor heating. Thicker timbers (18-21mm) have a slightly higher r-value of 0.17m² K/W which means heating will be more gradual, however the floor will retain the heat for longer.

To aid specifiers with building installation calculations, Forté have conducted independent testing for it's R Values.

Flooring Thickness	Collections	R-Value
12mm	Loft	Test Results Pending
14-15mm	Urban, Moda Vita, Artefact	0.11m ² K/W
18-21mm	Indus, Villa, Artiste Grande	0.17m ² K/W

8.2

LRV

LRV (light reflective value) measures the light that is reflected by a certain colour of stain/paint. LRV uses a scale from 0 – 100, with 0 being black and 100 being a bright white.

to the flooring colour may need to be considered depending on natural light, or lack there of, to obtain the desired colour for the space.

Design Considerations:

Consider the room where the flooring will be installed and how much natural light it receives throughout the day. Adjustments

Forté has conducted LRV testing on all its colours to BS8493 - these are listed below.

Collection	Colour	LRV
Artifact	Ammonite	17.53
	Amulet	20.23
	Flint	15.76
	Obsidian	10.37
Artiste Grande	Da Vinci	16.98
	Picasso	31.46
	Van Gogh	16.84
	Vermeer	12.59
Atelier	Classic	20.00
	Dolomite	35.00
	Granite	18.21
	Marl	18.76
	Siltstone	26.31
Indus	Atacama	25.93
	Colorado	19.71
	Kharan	36.06
	Mojave	33.78
	Patagonia	14.94
Sahara	20.78	
Tanami	20.54	

Collection	Colour	LRV
Loft	Astoria	36.57
	Brighton	34.51
	Brooklyn	25.86
	Claremont	34.90
	Harlem	10.39
	Manhattan	31.01
	Soho	8.30
	Stamford	30.18
	Tribeca	17.72
	Amalfi	38.36
Moda Vita	Capri	38.41
	Como	16.88
	Dolcedo	9.34
	Isola	11.21
	Mondello	32.18
	Sorrento	33.53
	Tuscany	20.16
	Verona	22.79
	Blond	33.32
	Clay	38.57
Smartfloor	Marron	11.02
	Natural	26.32
	Sandstone	19.73
	Tawny	26.18

Collection	Colour	LRV
Ultra	Bordeaux	30.77
	Champagne	26.73
	Driftwood	22.06
	Marbled	41.55
	Marron	11.42
	Mink Grey	19.61
	Tussock	18.61
	Barcelona	21.02
	Berlin	36.42
	Copenhagen	42.15
Urban	Milan	31.86
	New York	30.77
	Oslo	13.33
	Prague	8.43
	Seoul	28.27
	Tokyo	9.35
	Cashmere	35.17
Villa	Dune	34.92
	Limestone	32.13
	Raven	8.91
	Russet	11.99





9. Maintaining a Stable Climate

9.1

CONTROLLING AMBIENT TEMPERATURE AND HUMIDITY

Timber is hygroscopic, meaning that it will absorb/release moisture towards the EMC of the temperature & humidity of the area it is installed in. Therefore it is important to consider including ways to control the temperature & humidity in spaces where timber floor is installed.

AMBIENT RELATIVE HUMIDITY

An internal relative humidity of between 40% and 60% is ideal for timber flooring. There is an increasing risk of product movement and hairline cracks in the veneer degradation as humidity reaches outer ranges of below 35%, or above 75%. We strongly recommend the use of a humidification or dehumidification system to maintain relative humidity within these parameters.

Note: [BRANZ](#) recommends a relative humidity of 40-60% for optimum occupant comfort.

AMBIENT TEMPERATURE

Maintaining an average internal ambient temperature of between 16 and 27 degrees Celsius is recommended. The further outside this range increases the chance of product movement and hairline cracks in the veneer.

Note: [The Ministry of Social Development](#) recommends maintaining the internal temperature between 18 and 21 degrees Celsius.

9.2

CONTROLLING FLOOR SURFACE TEMPERATURE

SURFACE TEMPERATURE

It is important to protect the floor from extreme temperatures. Floor-to-ceiling windows coupled with the New Zealand sun have been known to create floor surface temperatures of over 70 degrees Celsius. It is recommended for homeowners to keep the floor surface temperature below 45 degrees Celsius when exposed to direct sunlight.

Where temperatures majorly or regularly exceed this level, there is a higher likelihood of cupping and warping, rapid deterioration of the product coating. Timber left exposed to direct, unfiltered UV rays will noticeably change in colour in the first 1-3 months. Changes in appearance may include darkening, lightening, or yellowing of the timber.

9.3

DESIGN CONSIDERATIONS

Filtering sunlight through curtains, blinds or UV treated windows and doors can reduce direct heat in rooms that are exposed to a lot of sun.





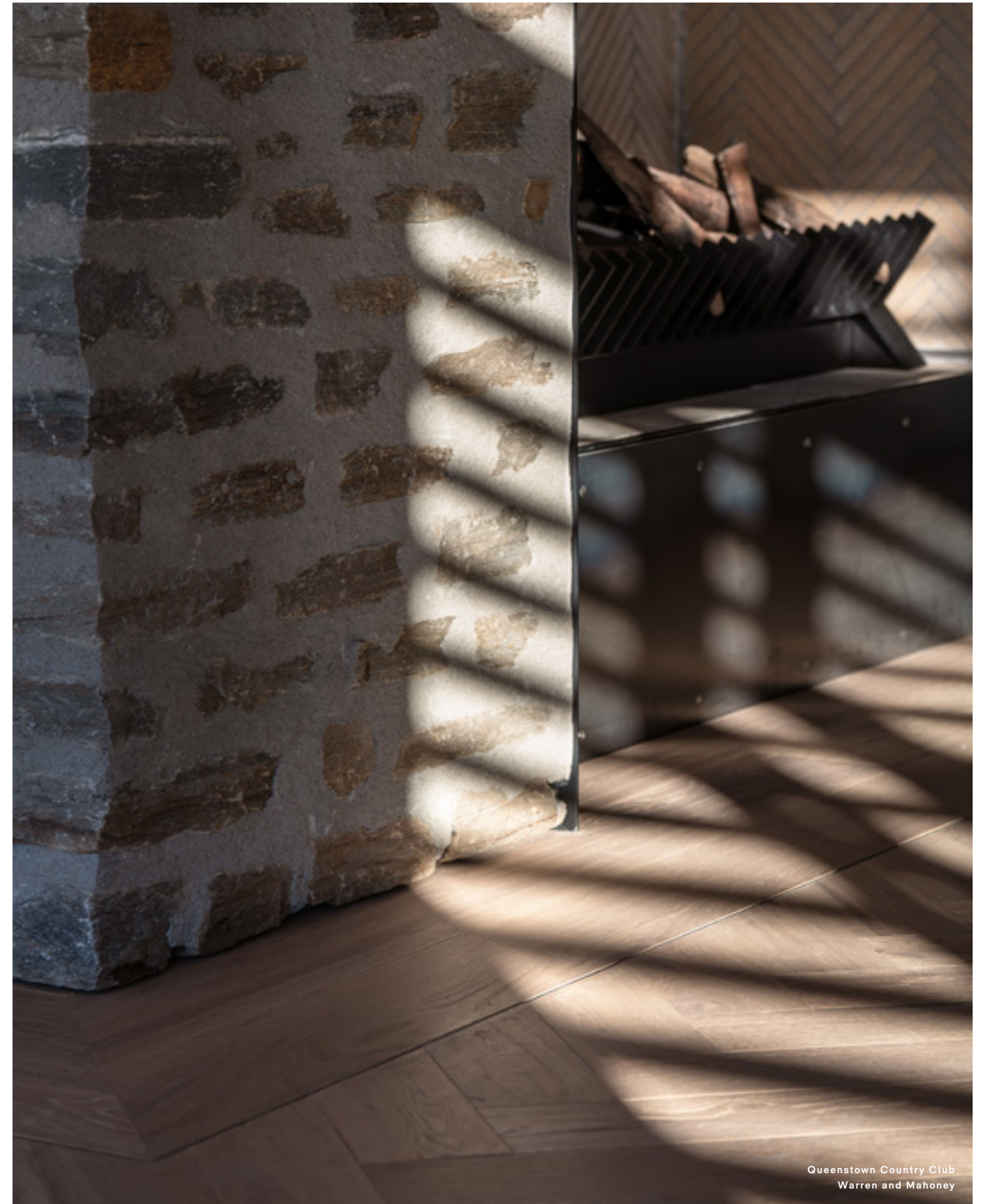

Note: The above design considerations should be regarded for homes that have large, north-facing joinery or homes that are north facing with no soffit.

For more information, refer to the "[Care and Maintenance Guide - Residential](#)"



Queenstown Country Club
Warren and Mahoney

10. Historic Products

Collection	Construction	Finish	Format	Dimensions	Phase-Out Date
 MANOR	2 Layer Engineered Birch Plywood	Hard Wax Oil	Plank Herringbone	2-Layer Engineered European Oak Veneer Birch Plywood Base	December 2018
 moda ALTRO	2 Layer Engineered Eucalyptus Plywood	Pre-finished Polyurethane	Plank Herringbone	2-Layer Engineered European Oak Veneer Birch Plywood Base	April 2024
 moda MEZZO	2 Layer Engineered Birch Plywood	Pre-finished Polyurethane	Plank	3-Layer Engineered European Oak Veneer Hevea Core Spruce Backing	January 2023
 moda STRETTO	2 Layer Engineered Meranti Plywood	Pre-finished Polyurethane	Plank Herringbone	3-Layer Engineered European Oak Veneer Hevea Core Spruce Backing	April 2024
 moda	2 Layer Engineered Eucalyptus Plywood	Pre-finished Polyurethane	Plank Herringbone	2-Layer Engineered European Oak Veneer Birch Plywood Base	March 2021
 PRO+PLANK	2 Layer Engineered Eucalyptus Plywood	Unfinished (surface coating applied onsite after installation)	Plank Herringbone	2-Layer Engineered European Oak Veneer Eucalypt Plywood Base	December 2019
 WOODLINE	3 Layer Engineered Hevea	Hard Wax Oil and Polyurethane (colour dependent, please enquire for more information)	Plank	3-Layer Engineered European Oak Veneer Hevea Core Spruce Backing	December 2017



Auckland
299 Great North Road,
Grey Lynn, Auckland

Pukekohe
3 Keith Place,
Pukekohe, Auckland

Christchurch
93 Manchester Street,
Christchurch

Queenstown
179 Glenda Drive,
Frankton, Queenstown

forte.co.nz
info@forte.co.nz
0508 35 66 77

